

Advanced Regulating Pulse Width Modulators

FEATURES

- Fully Interchangeable with Standard UC1524 Family
- Precision Reference Internally Trimmed to $\pm 1\%$
- High-Performance Current Limit Function
- Under-Voltage Lockout with Hysteretic Turn-on
- Start-Up Supply Current Less Than 4mA
- Output Current to 200mA
- 60V Output Capability
- Wide Common-Mode Input Range for both Error and Current Limit Amplifiers
- PWM Latch Insures Single Pulse per Period
- Double Pulse Suppression Logic
- 200ns Shutdown through PWM Latch
- Guaranteed Frequency Accuracy
- Thermal Shutdown Protection

DESCRIPTION

The UC1524A family of regulating PWM ICs has been designed to retain the same highly versatile architecture of the industry standard UC1524 (SG1524) while offering substantial improvements to many of its limitations. The UC1524A is pin compatible with "non-A" models and in most existing applications can be directly interchanged with no effect on power supply performance. Using the UC1524A, however, frees the designer from many concerns which typically had required additional circuitry to solve.

The UC1524A includes a precise 5V reference trimmed to $\pm 1\%$ accuracy, eliminating the need for potentiometer adjustments; an error amplifier with an input range which includes 5V, eliminating the need for a reference divider; a current sense amplifier useful in either the ground or power supply output lines; and a pair of 60V, 200mA uncommitted transistor switches which greatly enhance output versatility.

An additional feature of the UC1524A is an under-voltage lockout circuit which disables all the internal circuitry, except the reference, until the input voltage has risen to 8V. This holds standby current low until turn-on, greatly simplifying the design of low power, off-line supplies. The turn-on circuit has approximately 600mV of hysteresis for jitter-free activation.

Other product enhancements included in the UC1524A's design include a PWM latch which insures freedom from multiple pulsing within a period, even in noisy environments, logic to eliminate double pulsing on a single output, a 200ns external shutdown capability, and automatic thermal protection from excessive chip temperature. The oscillator circuit of the UC1524A is usable beyond 500kHz and is now easier to synchronize with an external clock pulse.

The UC1524A is packaged in a hermetic 16-pin DIP and is rated for operation from -55°C to $+125^{\circ}\text{C}$. The UC2524A and 3524A are available in either ceramic or plastic packages and are rated for operation from -40°C to $+85^{\circ}\text{C}$ and 0°C to 70°C , respectively. Surface mount devices are also available.

BLOCK DIAGRAM

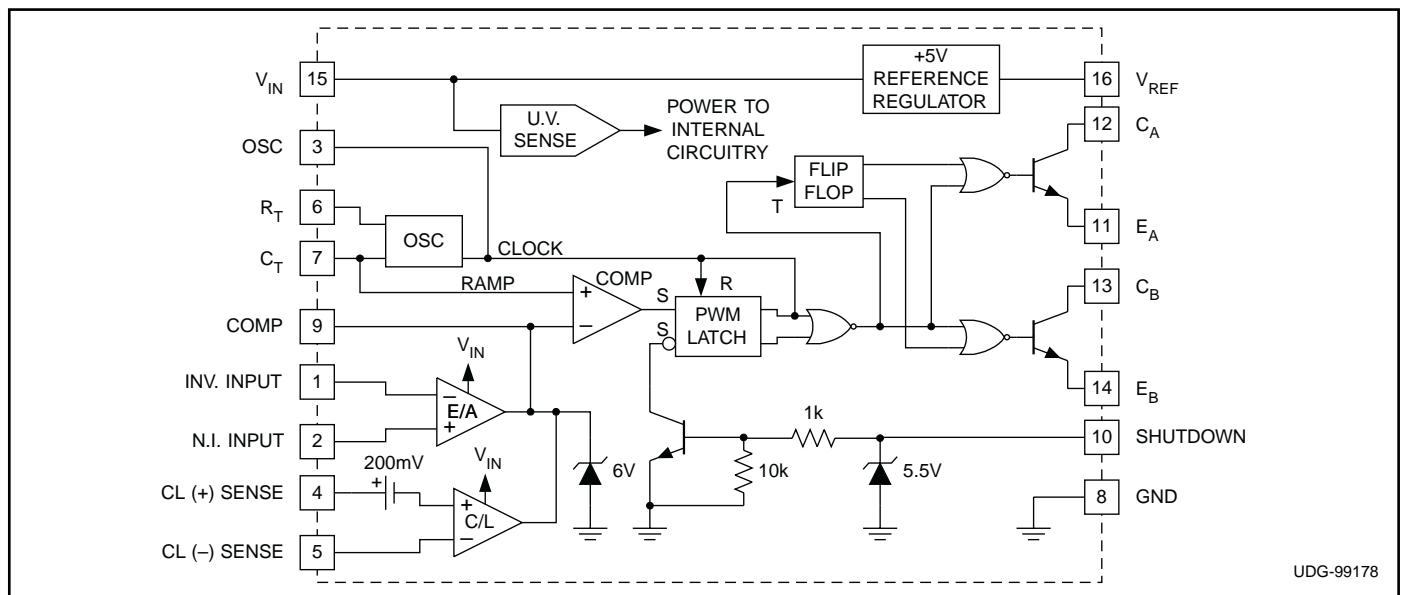

UDG-99178

ABSOLUTE MAXIMUM RATINGS

Supply Voltage (VIN) 40V
 Collector Supply Voltage (Vc) 60V
 Output Current (each Output) 200mA
 Maximum Forced Voltage (Pin 9, 10) -3 to +5V
 Maximum Forced Current (Pin 9, 10) ±10mA
 Reference Output Current 50mA
 Oscillator Charging Current 5mA
 Power Dissipation at TA = +25°C 1000mW
 Power Dissipation at Tc = +25°C 2000mW
 Operating Temperature Range -55°C to +125°C
 Storage Temperature Range -65°C to +150°C
 Lead Temperature, (Soldering, 10 seconds) +300°C
Note: Consult packaging section of Databook for thermal limitations and considerations of package.

CONNECTION DIAGRAMS

**PLCC-20, LCC-20 (TOP VIEW)
Q or L Package**

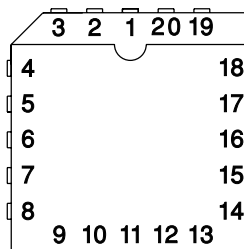

PACKAGE PIN FUNCTION	
FUNCTION	PIN
N/C	1
Inv. Input	2
Non-Inv. Input	3
OSC/SYNC	4
C.L. (+) sense	5
N/C	6
C.L. (-) sense	7
RT	8
CT	9
Ground	10
N/C	11
Compensation	12
Shutdown	13
Emitter A	14
Collector A	15
N/C	16
Collector B	17
Emitter B	18
+VIN	19
+5V VREF	20

**DIL-16, SOIC-16 (TOP VIEW)
J or N Package, DW Package**

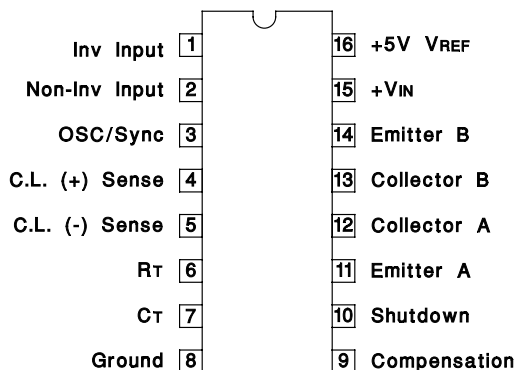

ELECTRICAL CHARACTERISTICS: Unless otherwise stated, these specifications apply for TA = -55°C to +125°C for the UC1524A, -40° to +85°C for the UC2524A, and 0°C to + 70°C for the UC3524A; VIN = Vc = 20V, TA = TJ.

PARAMETER	TEST CONDITIONS	UC1524A / UC2524A			UC3524A			UNITS
		MIN	TYP	MAX	MIN	TYP	MAX	
Turn-on Characteristics								
Input Voltage	Operating Range after Turn-on	8		40	8		40	V
Turn-on Threshold		6.5	7.5	8.5	6.5	7.5	8.5	V
Turn-on Current	VIN = 6V		2.5	4		2.5	4	mA
Operating Current	VIN = 8 to 40V		5	10		5	10	mA
Turn-on Hysteresis*			0.5			0.5		V
Reference Section								
Output Voltage	TJ = 25°C	4.95	5.00	5.05	4.90	5.00	5.10	V
	Over Operating Range	4.9		5.1	4.85		5.15	V
Line Regulation	VIN = 10 to 40V		10	20		10	30	mV
Load Regulation	IL = 0 to 20 mA		20	25		20	35	mV
Temperature Stability*	Over Operating Range*		20	25		20	35	mV
Short Circuit Current	VREF = 0, 25°C ≤ TJ ≤ 125°C		80	100		80	100	mA
Output Noise Voltage*	10Hz ≤ f ≤ 10kHz, TJ = 25°C		40			40		μVrms
Long Term Stability*	TJ = 125°C, 1000 Hrs.		20	50		20	50	mV

* These parameters are ensured by design but not 100% tested in production.

ELECTRICAL CHARACTERISTICS: Unless otherwise stated, these specifications apply for $T_A = -55^{\circ}\text{C}$ to $+125^{\circ}\text{C}$ for the UC1524A, -40° to $+85^{\circ}\text{C}$ for the UC2524A, and 0°C to $+70^{\circ}\text{C}$ for the UC3524A; $V_{IN} = V_C = 20\text{V}$, $T_A = T_J$.

PARAMETER	TEST CONDITIONS	UC1524A / UC2524A			UC3524A			UNITS
		MIN	TYP	MAX	MIN	TYP	MAX	
Oscillator Section (Unless otherwise specified, $R_T = 2700\Omega$, $C_T = 0.01\text{ mfd}$)								
Initial Accuracy	$T_J = 25^{\circ}\text{C}$	41	43	45	39	43	47	kHz
	Over Operating Range	40.2		45.9	38.2		47.9	kHz
Temperature Stability*	Over Operating Temperature Range		1	2		1	2	%
Minimum Frequency	$R_T = 150\text{k}\Omega$, $C_T = 0.1\text{ mfd}$			140			120	Hz
Maximum Frequency	$R_T = 2.0\text{k}\Omega$, $C_T = 470\text{pF}$	500			500			kHz
Output Amplitude*		3	3.5		3	3.5		V
Output Pulse Width*		0.29	0.5	1.0	0.3	0.5	1.0	μs
Ramp Peak		3.3	3.5	3.7	3.3	3.5	3.7	V
Ramp Valley	$T_J = 25^{\circ}\text{C}$	0.7	0.8	0.9	0.7	0.8	0.9	V
Ramp Valley T.C.			-1.0			-1.0		mV/ $^{\circ}\text{C}$
Error Amplifier Section (Unless otherwise specified, $V_{CM} = 2.5\text{V}$)								
Input Offset Voltage			0.5	5		2	10	mV
Input Bias Current			1	5		1	10	μA
Input Offset Current			.05	1		0.5	1	μA
Common Mode Rejection Ratio	$V_{CM} = 1.5$ to 5.5V	70	80		70	80		dB
Power Supply Rejection Ratio	$V_{IN} = 10$ to 40V	70	80		70	80		dB
Output Swing (Note 1)		5.0		0.5	5.0		0.5	V
Open Loop Voltage Gain	$\Delta V_O = 1$ to 4V , $R_L \geq 10\text{M}\Omega$	72	80		64	80		dB
Gain-Bandwidth*	$T_J = 25^{\circ}\text{C}$, $A_V = 0\text{dB}$	1	3		1	3		MHz
DC Transconductance*§	$T_J = 25^{\circ}\text{C}$, $30\text{k}\Omega \leq R_L \leq 1\text{M}\Omega$	1.7	2.3		1.7	2.3		mS
P.W.M. Comparator ($R_T = 2\text{k}\Omega$, $C_T = 0.01\text{ mfd}$)								
Minimum Duty Cycle	$V_{COMP} = 0.5\text{V}$			0			0	%
Maximum Duty Cycle	$V_{COMP} = 3.8\text{V}$	45			45			%
Current Limit Amplifier (Unless otherwise specified, Pin 5 = 0V)								
Input Offset Voltage	$T_J = 25^{\circ}\text{C}$, E/A Set for Maximum Output	190	200	210	180	200	220	mV
	Over Operating Temperature Range	180		220	170		230	mV
Input Bias Current			-1	-10		-1	-10	μA
Common Mode Rejection Ratio	$V_{(\text{pin } 5)} = -0.3\text{V}$ to $+5.5\text{V}$	50	60		50	60		dB
Power Supply Rejection Ratio	$V_{IN} = 10$ to 40V	50	60		50	60		dB
Output Swing (Note 1)	Minimum Total Range	5.0		0.5	5.0		0.5	V
Open-Loop Voltage Gain	$\Delta V_O = 1$ to 4V , $R_L \geq 10\text{M}\Omega$	70	80		70	80		dB
Delay Time*	Pin 4 to Pin 9, $\Delta V_{IN} = 300\text{mV}$		300			300		ns
Output Section (Each Output)								
Collector Emitter Voltage	$I_C = 100\mu\text{A}$	60	80		60	80		V
Collector Leakage Current	$V_{CE} = 50\text{V}$.1	20		.1	20	μA

* These parameters are ensured by design but not 100% tested in production.

§ DC transconductance (gm) relates to DC open-loop voltage gain according to the following equation: $A_V = gmR_L$ where R_L is the resistance from pin 9 to the common mode voltage.

The minimum gm specification is used to calculate minimum A_V when the error amplifier output is loaded.

Note 1: Min Limit applies to output high level, max limit applies to output low level.

ELECTRICAL CHARACTERISTICS: Unless otherwise stated, these specifications apply for $T_A = -55^\circ\text{C}$ to $+125^\circ\text{C}$ for the UC1524A, -40° to $+85^\circ\text{C}$ for the UC2524A, and 0°C to $+70^\circ\text{C}$ for the UC3524A; $V_{IN} = V_C = 20\text{V}$. $T_A = T_J$.

PARAMETER	TEST CONDITIONS	UC1524A / UC2524A			UC3524A			UNITS
		MIN	TYP	MAX	MIN	TYP	MAX	
Output Section (cont.) (Each Output)								
Saturation Voltage	$I_C = 20\text{mA}$ $I_C = 200\text{mA}$.2 1	.4 2.2		.2 1	.4 2.2	V V
Emitter Output Voltage	$I_E = 50\text{mA}$	17	18		17	18		V
Rise Time*	$T_J = 25^\circ\text{C}$, $R = 2\text{k}\Omega$		120	400		120	400	ns
Fall Time*	$T_J = 25^\circ\text{C}$, $R = 2\text{k}\Omega$		25	200		25	200	ns
Comparator Delay*	$T_J = 25^\circ\text{C}$, Pin 9 to output		300			300		ns
Shutdown Delay*	$T_J = 25^\circ\text{C}$, Pin 10 to output		200			200		ns
Shutdown Threshold	$T_J = 25^\circ\text{C}$, $R_C = 2\text{k}\Omega$	0.6	.7	1.0	0.6	.7	1.0	V
S/D Threshold Over Temp.	Over Operating Temperature Range	0.4		1.2	0.4		1.0	V
Thermal Shutdown*			165			165		$^\circ\text{C}$

* These parameters are ensured by design but not 100% tested in production.

OPEN-LOOP CIRCUIT

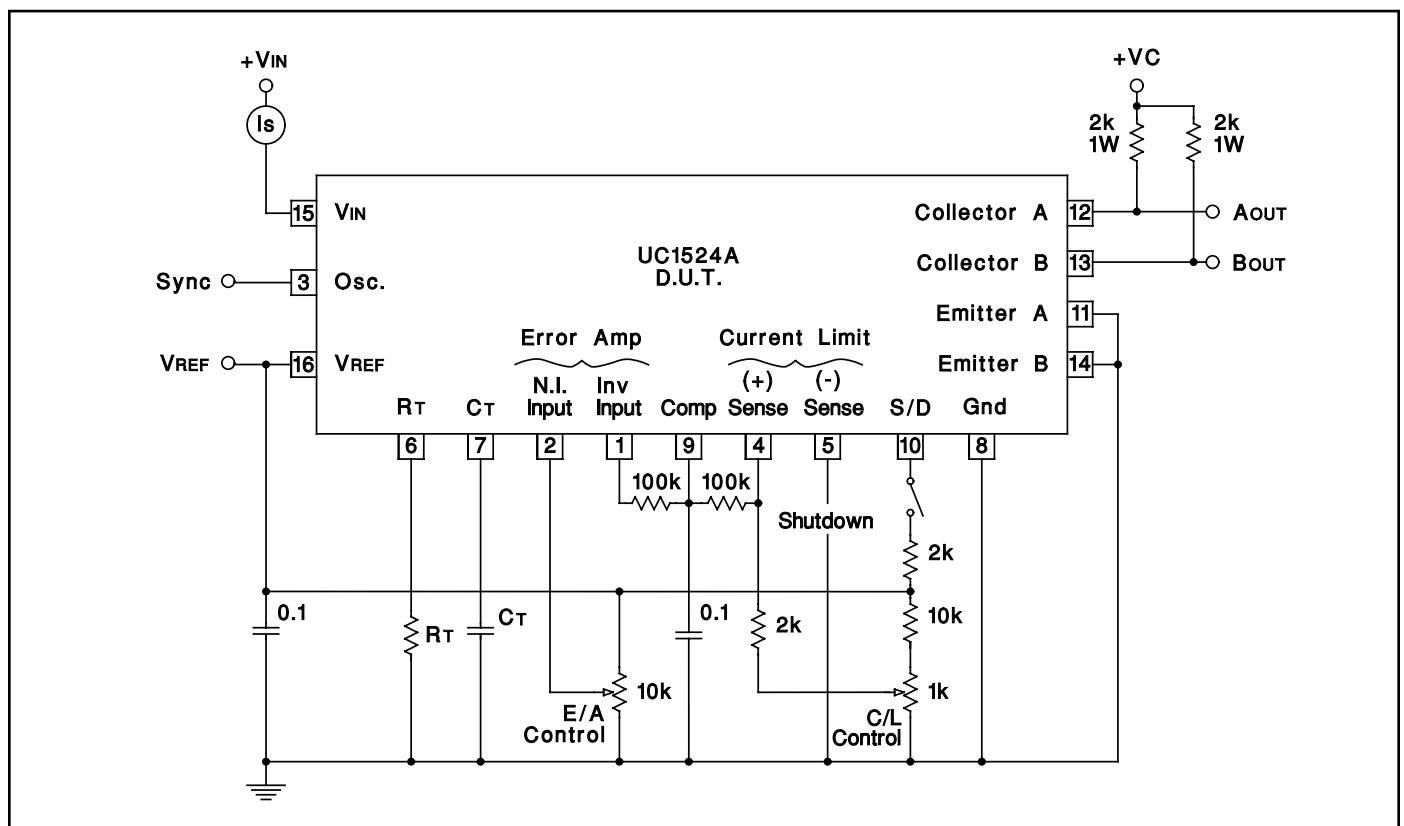

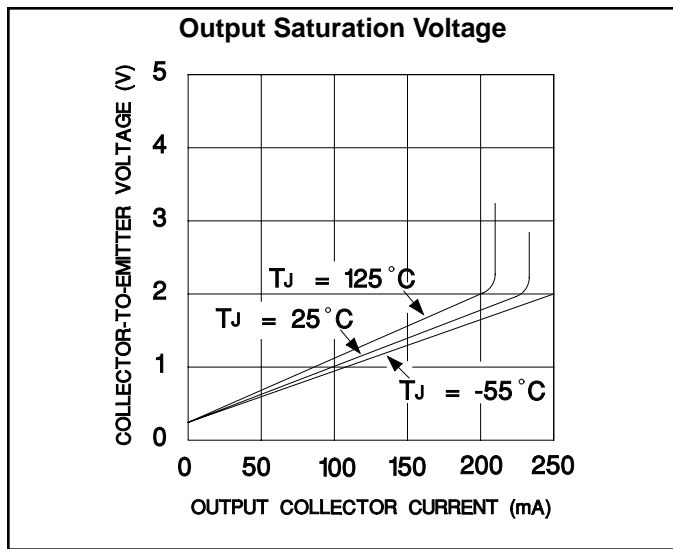
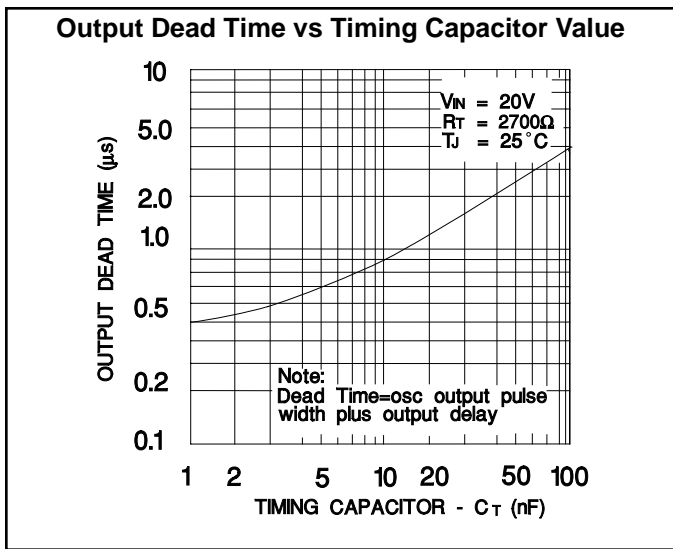
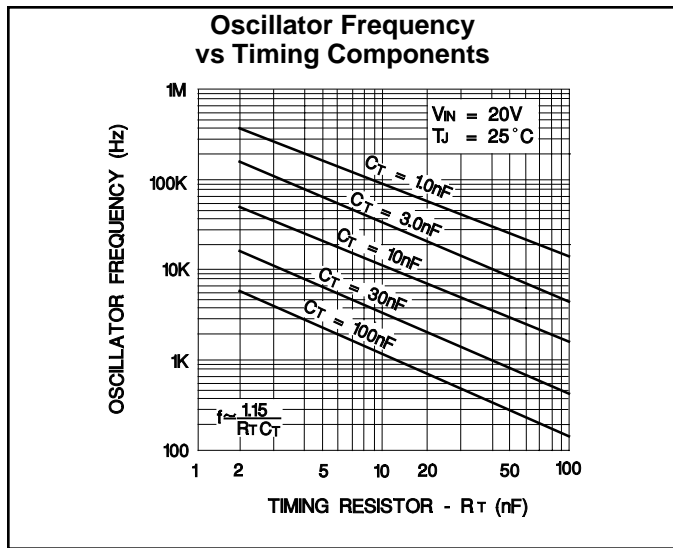
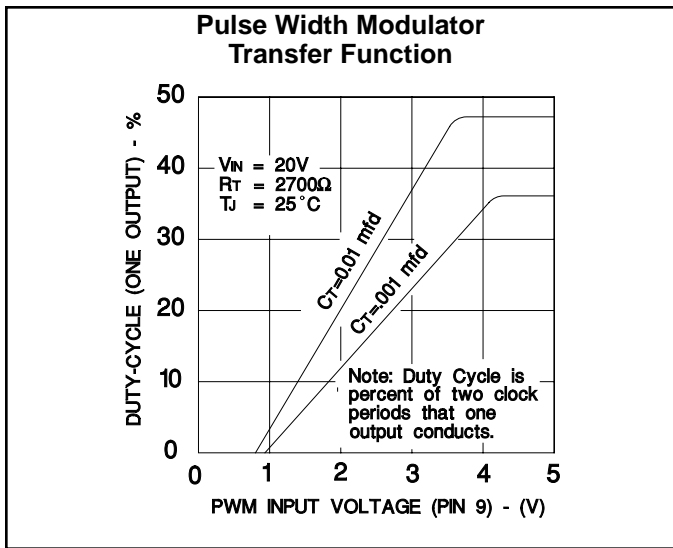
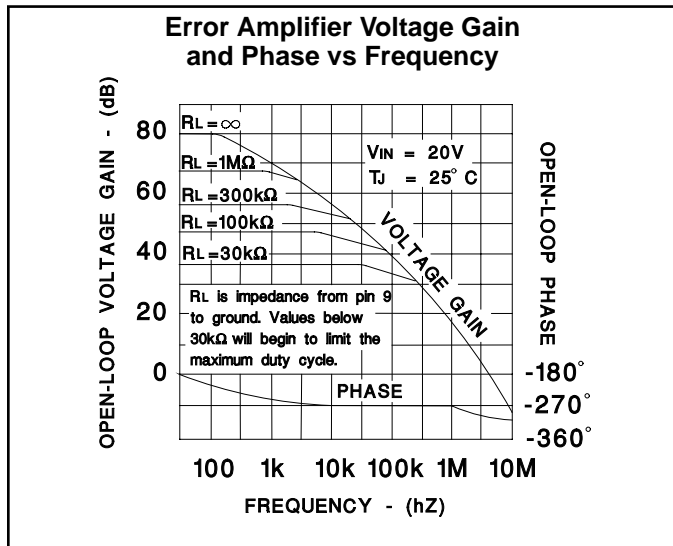
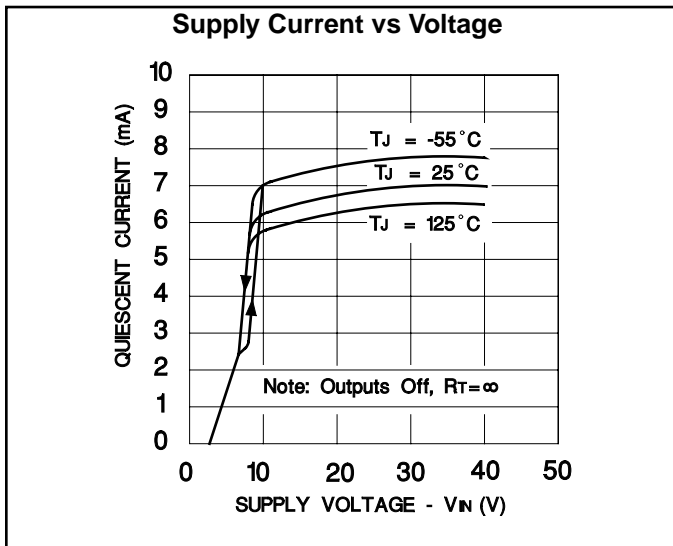

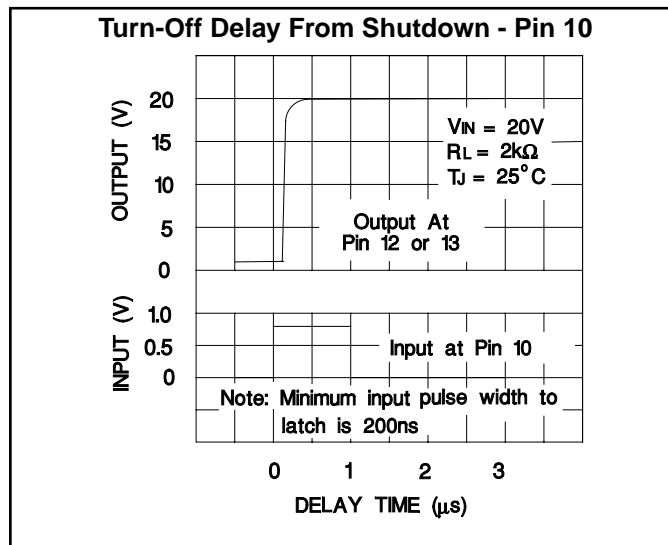
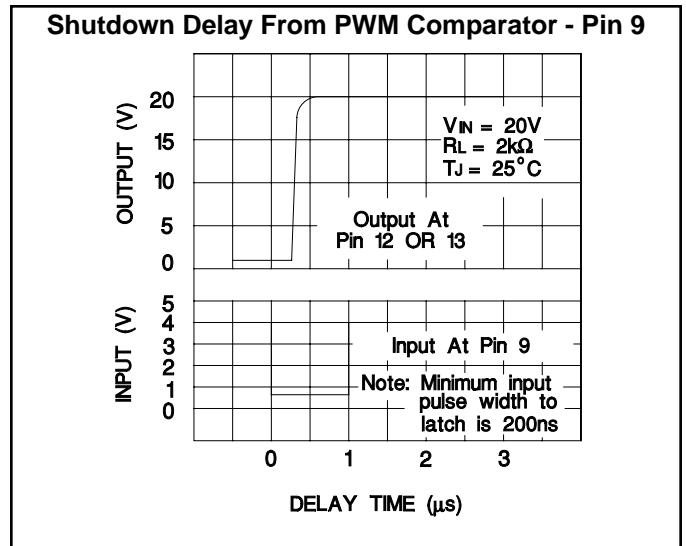
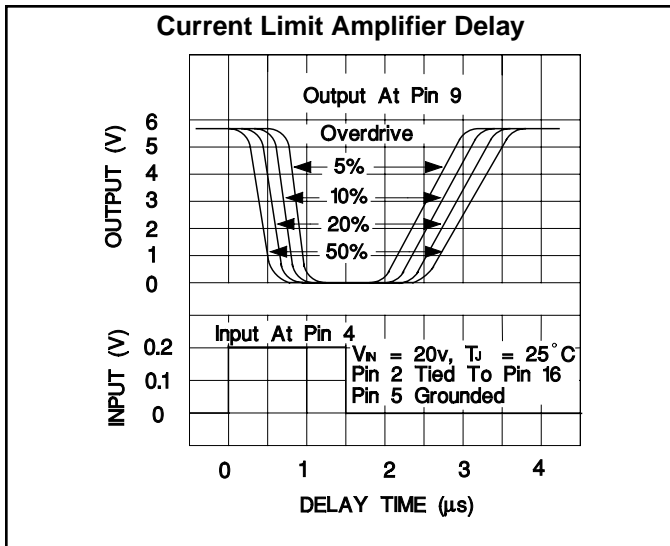

PACKAGING INFORMATION

Orderable Device	Status ⁽¹⁾	Package Type	Package Drawing	Pins	Package Qty	Eco Plan ⁽²⁾	Lead/Ball Finish	MSL Peak Temp ⁽³⁾
5962-8764502EA	ACTIVE	CDIP	J	16	1	None	A42 SNPB	Level-NC-NC-NC
UC1524AJ	ACTIVE	CDIP	J	16	1	None	A42 SNPB	Level-NC-NC-NC
UC1524AJ/80503	ACTIVE	CDIP	J	16	1	None	A42 SNPB	Level-NC-NC-NC
UC1524AJ883B	ACTIVE	CDIP	J	16	1	None	A42 SNPB	Level-NC-NC-NC
UC1524AL	ACTIVE	LCCC	FK	20	1	None	POST-PLATE	Level-NC-NC-NC
UC1524AL883B	ACTIVE	LCCC	FK	20	1	None	POST-PLATE	Level-NC-NC-NC
UC2524ADW	ACTIVE	SOIC	DW	16	40	None	CU NIPDAU	Level-2-220C-1 YEAR
UC2524ADWTR	ACTIVE	SOIC	DW	16	2000	None	CU NIPDAU	Level-2-220C-1 YEAR
UC2524AJ	ACTIVE	CDIP	J	16	1	None	A42 SNPB	Level-NC-NC-NC
UC2524AN	ACTIVE	PDIP	N	16	25	None	CU SNPB	Level-NA-NA-NA
UC2524ANG4	ACTIVE	PDIP	N	16	1000	Green (RoHS & no Sb/Br)	CU NIPDAU	Level-NA-NA-NA
UC3524ADW	ACTIVE	SOIC	DW	16	40	None	CU NIPDAU	Level-2-220C-1 YEAR
UC3524ADWTR	ACTIVE	SOIC	DW	16	2000	None	CU NIPDAU	Level-2-220C-1 YEAR
UC3524AJ	ACTIVE	CDIP	J	16	1	None	A42 SNPB	Level-NC-NC-NC
UC3524AN	ACTIVE	PDIP	N	16	25	None	CU SNPB	Level-NA-NA-NA

⁽¹⁾ The marketing status values are defined as follows:

ACTIVE: Product device recommended for new designs.

LIFEBUY: TI has announced that the device will be discontinued, and a lifetime-buy period is in effect.

NRND: Not recommended for new designs. Device is in production to support existing customers, but TI does not recommend using this part in a new design.

PREVIEW: Device has been announced but is not in production. Samples may or may not be available.

OBSOLETE: TI has discontinued the production of the device.

⁽²⁾ Eco Plan - May not be currently available - please check <http://www.ti.com/productcontent> for the latest availability information and additional product content details.

None: Not yet available Lead (Pb-Free).

Pb-Free (RoHS): TI's terms "Lead-Free" or "Pb-Free" mean semiconductor products that are compatible with the current RoHS requirements for all 6 substances, including the requirement that lead not exceed 0.1% by weight in homogeneous materials. Where designed to be soldered at high temperatures, TI Pb-Free products are suitable for use in specified lead-free processes.

Green (RoHS & no Sb/Br): TI defines "Green" to mean "Pb-Free" and in addition, uses package materials that do not contain halogens, including bromine (Br) or antimony (Sb) above 0.1% of total product weight.

⁽³⁾ MSL, Peak Temp. -- The Moisture Sensitivity Level rating according to the JEDEC industry standard classifications, and peak solder temperature.

Important Information and Disclaimer: The information provided on this page represents TI's knowledge and belief as of the date that it is provided. TI bases its knowledge and belief on information provided by third parties, and makes no representation or warranty as to the accuracy of such information. Efforts are underway to better integrate information from third parties. TI has taken and continues to take reasonable steps to provide representative and accurate information but may not have conducted destructive testing or chemical analysis on incoming materials and chemicals. TI and TI suppliers consider certain information to be proprietary, and thus CAS numbers and other limited information may not be available for release.

In no event shall TI's liability arising out of such information exceed the total purchase price of the TI part(s) at issue in this document sold by TI to Customer on an annual basis.

IMPORTANT NOTICE

Texas Instruments Incorporated and its subsidiaries (TI) reserve the right to make corrections, modifications, enhancements, improvements, and other changes to its products and services at any time and to discontinue any product or service without notice. Customers should obtain the latest relevant information before placing orders and should verify that such information is current and complete. All products are sold subject to TI's terms and conditions of sale supplied at the time of order acknowledgment.

TI warrants performance of its hardware products to the specifications applicable at the time of sale in accordance with TI's standard warranty. Testing and other quality control techniques are used to the extent TI deems necessary to support this warranty. Except where mandated by government requirements, testing of all parameters of each product is not necessarily performed.

TI assumes no liability for applications assistance or customer product design. Customers are responsible for their products and applications using TI components. To minimize the risks associated with customer products and applications, customers should provide adequate design and operating safeguards.

TI does not warrant or represent that any license, either express or implied, is granted under any TI patent right, copyright, mask work right, or other TI intellectual property right relating to any combination, machine, or process in which TI products or services are used. Information published by TI regarding third-party products or services does not constitute a license from TI to use such products or services or a warranty or endorsement thereof. Use of such information may require a license from a third party under the patents or other intellectual property of the third party, or a license from TI under the patents or other intellectual property of TI.

Reproduction of information in TI data books or data sheets is permissible only if reproduction is without alteration and is accompanied by all associated warranties, conditions, limitations, and notices. Reproduction of this information with alteration is an unfair and deceptive business practice. TI is not responsible or liable for such altered documentation.

Resale of TI products or services with statements different from or beyond the parameters stated by TI for that product or service voids all express and any implied warranties for the associated TI product or service and is an unfair and deceptive business practice. TI is not responsible or liable for any such statements.

Following are URLs where you can obtain information on other Texas Instruments products and application solutions:

Products		Applications	
Amplifiers	amplifier.ti.com	Audio	www.ti.com/audio
Data Converters	dataconverter.ti.com	Automotive	www.ti.com/automotive
DSP	dsp.ti.com	Broadband	www.ti.com/broadband
Interface	interface.ti.com	Digital Control	www.ti.com/digitalcontrol
Logic	logic.ti.com	Military	www.ti.com/military
Power Mgmt	power.ti.com	Optical Networking	www.ti.com/opticalnetwork
Microcontrollers	microcontroller.ti.com	Security	www.ti.com/security
		Telephony	www.ti.com/telephony
		Video & Imaging	www.ti.com/video
		Wireless	www.ti.com/wireless

Mailing Address: Texas Instruments
Post Office Box 655303 Dallas, Texas 75265

This datasheet has been download from:

www.datasheetcatalog.com

Datasheets for electronics components.