

General purpose JFET quad operational amplifiers

Datasheet — production data

Features

- Wide common-mode (up to V_{CC^+}) and differential voltage range
- Low input bias and offset current
- Output short-circuit protection
- High input impedance JFET input stage
- Internal frequency compensation
- Latch up free operation
- High slew rate: 16 V/ μ s (typical)

Description

The TL084, TL084A and TL084B are high-speed JFET input quad operational amplifiers incorporating well matched, high voltage JFET and bipolar transistors in a monolithic integrated circuit.

The devices feature high slew rates, low input bias and offset currents, and low offset voltage temperature coefficient.

N
DIP14
(Plastic package)

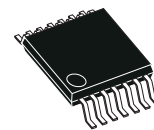

D
TSSOP-14
(Thin shrink small outline package)

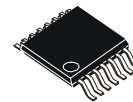

D
SO-14
(Plastic micropackage)

Pin connections
(Top view)

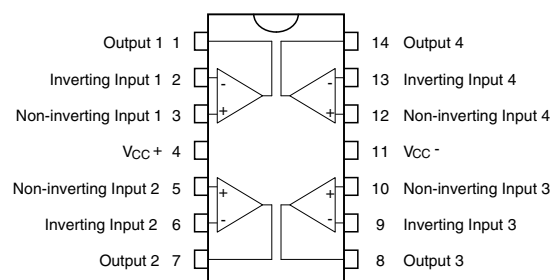

1 Schematic diagram

Figure 1. Circuit schematics (for each amplifier)

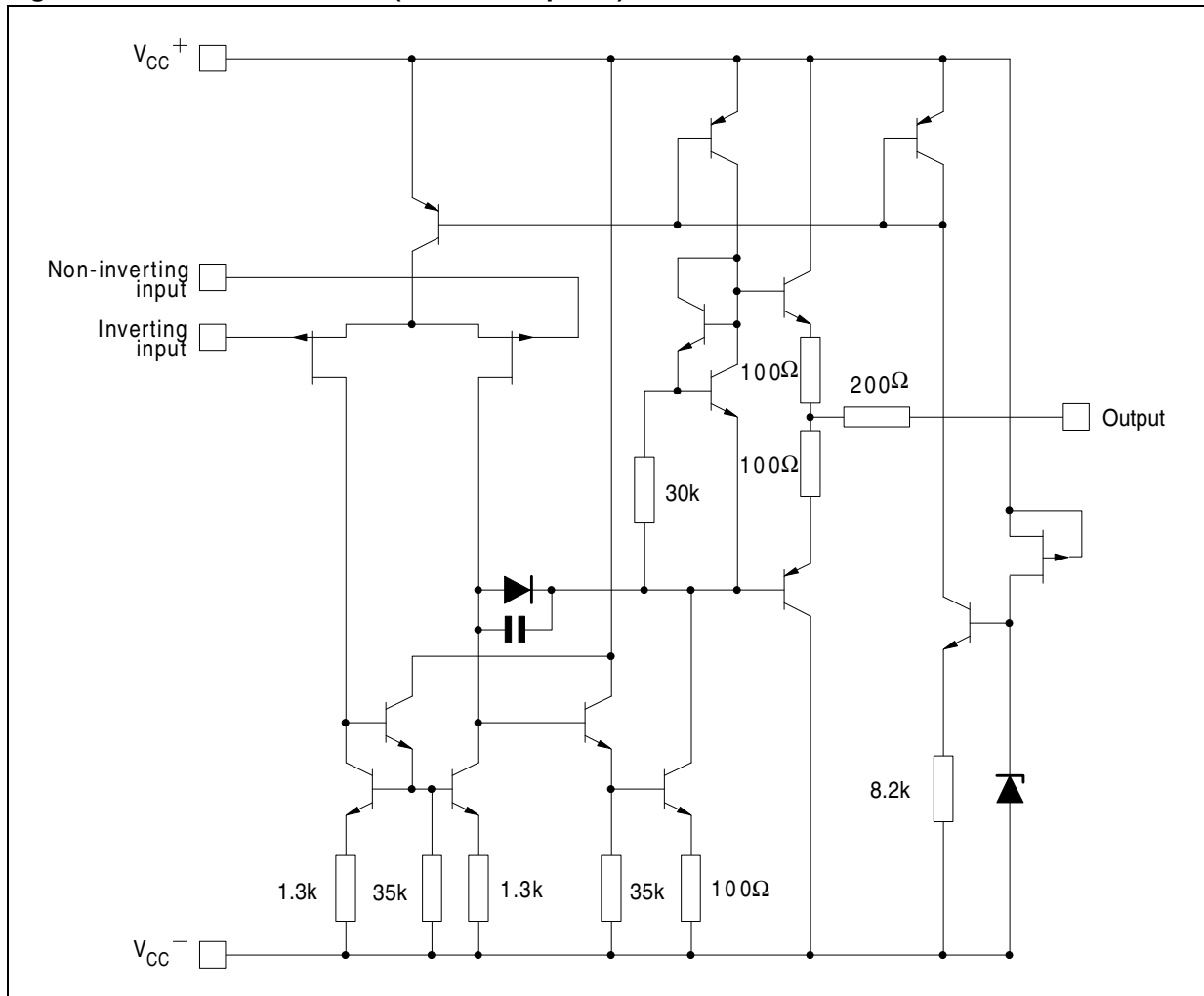

2 Absolute maximum ratings and operating conditions

Table 1. Absolute maximum ratings

Symbol	Parameter	Value		Unit
		TL084I, AI, BI	TL084C, AC, BC	
V_{CC}	Supply voltage ⁽¹⁾	±18		V
V_{in}	Input voltage ⁽²⁾	±15		V
V_{id}	Differential input voltage ⁽³⁾	±30		V
R_{thja}	Thermal resistance junction to ambient ⁽⁴⁾ ⁽⁵⁾			°C/W
	SO-14	105		
	DIP14 TSSOP14	80 100		
R_{thjc}	Thermal resistance junction to case ⁽⁴⁾ ⁽⁵⁾			°C/W
	SO-14	31		
	DIP14 TSSOP14	33 32		
P_{tot}	Power dissipation	680		mW
	Output short-circuit duration ⁽⁶⁾	Infinite		
T_{oper}	Operating free-air temperature range	-40 to +105	0 to +70	°C
T_{stg}	Storage temperature range	-65 to +150		°C
ESD	HBM: human body model ⁽⁷⁾	1000		V
	MM: machine model ⁽⁸⁾	150		
	CDM: charged device model ⁽⁹⁾	1500		

1. All voltage values, except differential voltage, are with respect to the zero reference level (ground) of the supply voltages where the zero reference level is the midpoint between V_{CC}^+ and V_{CC}^- .
2. The magnitude of the input voltage must never exceed the magnitude of the supply voltage or 15 volts, whichever is less.
3. Differential voltages are the non-inverting input terminal with respect to the inverting input terminal.
4. Short-circuits can cause excessive heating and destructive dissipation.
5. R_{th} are typical values.
6. The output may be shorted to ground or to either supply. Temperature and/or supply voltages must be limited to ensure that the dissipation rating is not exceeded.
7. Human body model: 100 pF discharged through a 1.5 kΩ resistor between two pins of the device, done for all couples of pin combinations with other pins floating.
8. Machine model: a 200 pF cap is charged to the specified voltage, then discharged directly between two pins of the device with no external series resistor (internal resistor < 5 Ω), done for all couples of pin combinations with other pins floating.
9. Charged device model: all pins plus package are charged together to the specified voltage and then discharged directly to the ground.

Table 2. Operating conditions

Symbol	Parameter	TL084I, AI, BI	TL084C, AC, BC	Unit
V_{CC}	Supply voltage range	6 to 36		V
T_{oper}	Operating free-air temperature range	-40 to +105	0 to +70	°C

3 Electrical characteristics

Table 3. $V_{CC} = \pm 15V$, $T_{amb} = +25^{\circ}C$ (unless otherwise specified)

Symbol	Parameter	TL084I,AC,AI,BC,BI			TL084C			Unit
		Min.	Typ.	Max.	Min.	Typ.	Max.	
V_{io}	Input offset voltage ($R_S = 50\Omega$) $T_{amb} = +25^{\circ}C$ TL084 TL084A TL084B $T_{min} \leq T_{amb} \leq T_{max}$ TL084 TL084A TL084B		3 3 1	10 6 3 13 7 5		3	10	mV
DV_{io}	Input offset voltage drift		10			10		$\mu V/^{\circ}C$
I_{io}	Input offset current $T_{amb} = +25^{\circ}C$ $T_{min} \leq T_{amb} \leq T_{max}$		5	100 4		5	100 4	pA nA
I_{ib}	Input bias current ⁽¹⁾ $T_{amb} = +25^{\circ}C$ $T_{min} \leq T_{amb} \leq T_{max}$		20	200 20		30	200 20	pA nA
A_{vd}	Large signal voltage gain ($R_L = 2k\Omega$, $V_o = \pm 10V$) $T_{amb} = +25^{\circ}C$ $T_{min} \leq T_{amb} \leq T_{max}$	50 25	200		25 15	200		V/mV
SVR	Supply voltage rejection ratio ($R_S = 50\Omega$) $T_{amb} = +25^{\circ}C$ $T_{min} \leq T_{amb} \leq T_{max}$	80 80	86		70 70	86		dB
I_{CC}	Supply current, no load $T_{amb} = +25^{\circ}C$ $T_{min} \leq T_{amb} \leq T_{max}$		1.4	2.5 2.5		1.4	2.5 2.5	mA
V_{icm}	Input common mode voltage range	± 11	+15 -12		± 11	+15 -12		V
CMR	Common mode rejection ratio ($R_S = 50\Omega$) $T_{amb} = +25^{\circ}C$ $T_{min} \leq T_{amb} \leq T_{max}$	80 80	86		70 70	86		dB
I_{os}	Output short-circuit current $T_{amb} = +25^{\circ}C$ $T_{min} \leq T_{amb} \leq T_{max}$	10 10	40	60 60	10 10	40	60 60	mA
$\pm V_{opp}$	Output voltage swing $T_{amb} = +25^{\circ}C$ $R_L = 2k\Omega$ $R_L = 10k\Omega$ $T_{min} \leq T_{amb} \leq T_{max}$ $R_L = 2k\Omega$ $R_L = 10k\Omega$	10 12 10 12	12 13.5		10 12 10 12	12 13.5		V
SR	Slew rate $V_{in} = 10V$, $R_L = 2k\Omega$, $C_L = 100pF$, unity gain	8	16		8	16		V/ μs

Table 3. $V_{CC} = \pm 15V$, $T_{amb} = +25^{\circ}C$ (unless otherwise specified) (continued)

Symbol	Parameter	TL084I,AC,AI, BC,BI			TL084C			Unit
		Min.	Typ.	Max.	Min.	Typ.	Max.	
t_r	Rise time $V_{in} = 20mV$, $R_L = 2k\Omega$, $C_L = 100pF$, unity gain		0.1			0.1		μs
K_{ov}	Overshoot $V_{in} = 20mV$, $R_L = 2k\Omega$, $C_L = 100pF$, unity gain		10			10		%
GBP	Gain bandwidth product $V_{in} = 10mV$, $R_L = 2k\Omega$, $C_L = 100pF$, $F = 100kHz$	2.5	4		2.5	4		MHz
R_i	Input resistance		10^{12}			10^{12}		Ω
THD	Total harmonic distortion $F = 1kHz$, $R_L = 2k\Omega$, $C_L = 100pF$, $A_v = 20dB$, $V_o = 2V_{pp}$)		0.01			0.01		%
e_n	Equivalent input noise voltage $R_S = 100\Omega$, $F = 1kHz$		15			15		$\frac{nV}{\sqrt{Hz}}$
ϕ_m	Phase margin		45			45		degrees
V_{o1}/V_{o2}	Channel separation $A_v = 100$		120			120		dB

1. The input bias currents are junction leakage currents which approximately double for every $10^{\circ}C$ increase in the junction temperature.

Figure 2. Maximum peak-to-peak output voltage versus frequency ($R_L = 2k\Omega$)

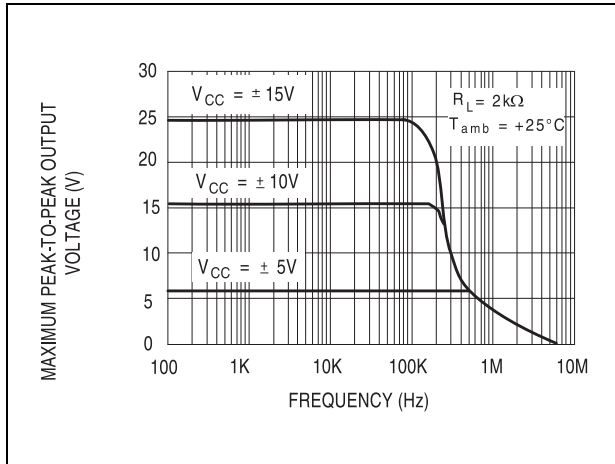

Figure 3. Maximum peak-to-peak output voltage versus frequency ($R_L = 10k\Omega$)

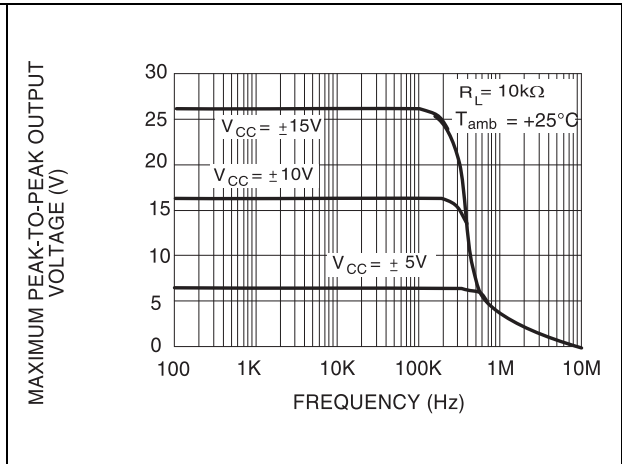

Figure 4. Maximum peak-to-peak output voltage versus frequency

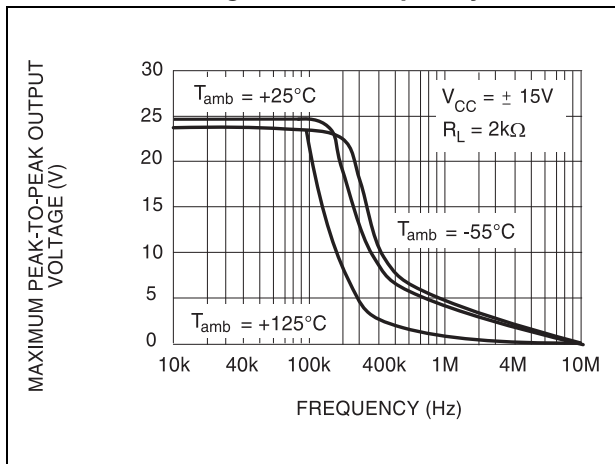

Figure 5. Maximum peak-to-peak output voltage versus free air temperature

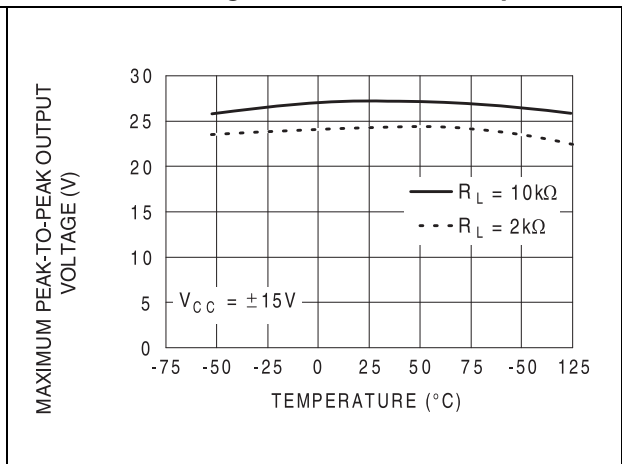

Figure 6. Maximum peak-to-peak output voltage versus load resistance

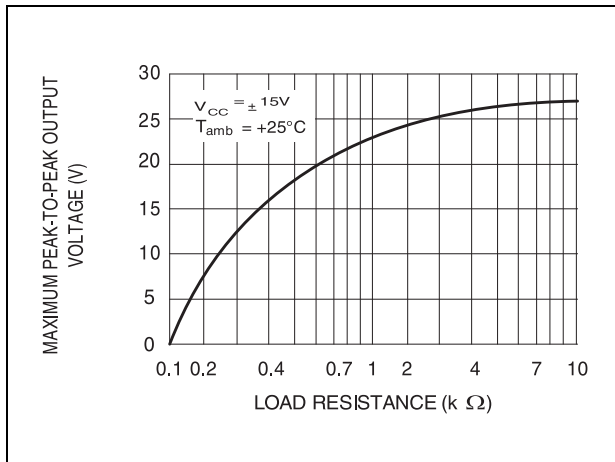

Figure 7. Maximum peak-to-peak output voltage versus supply voltage

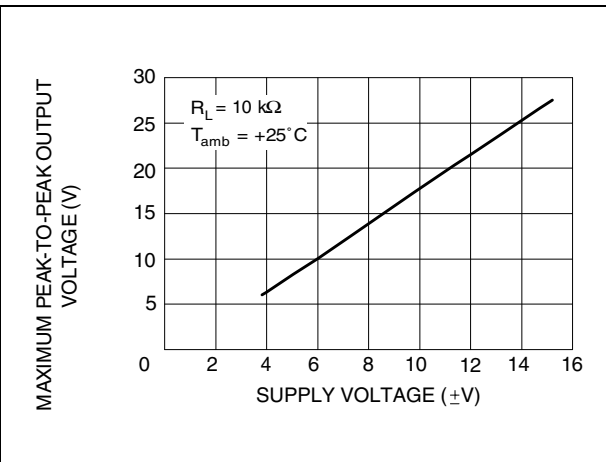

Figure 8. Input bias current versus free air temperature

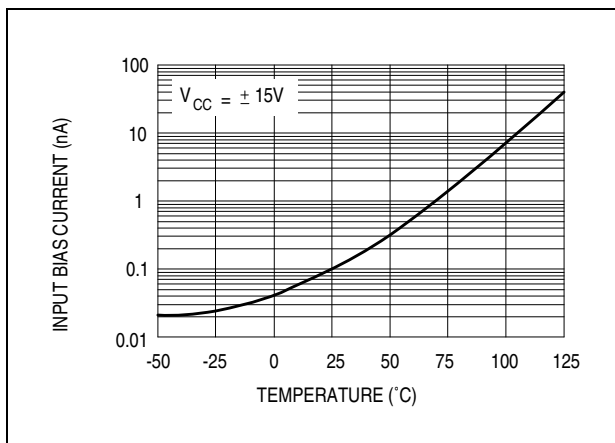

Figure 9. Large signal differential voltage amplification versus free air temperature

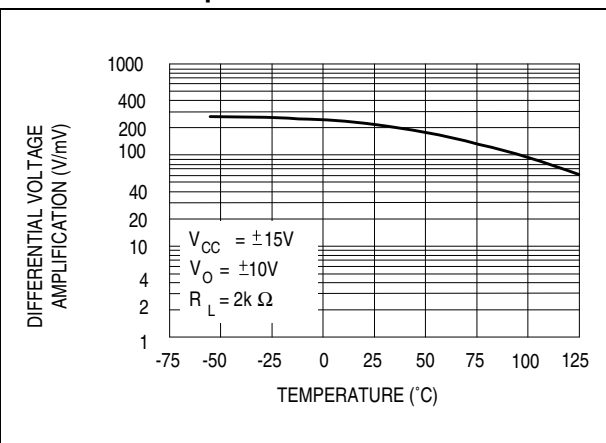

Figure 10. Large signal differential voltage amplification and phase shift versus frequency

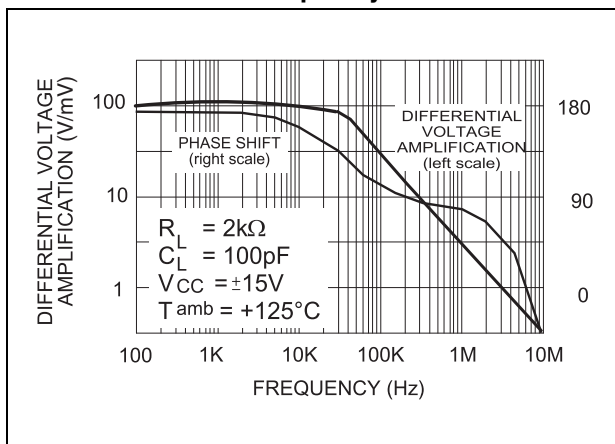

Figure 11. Total power dissipation versus free air temperature

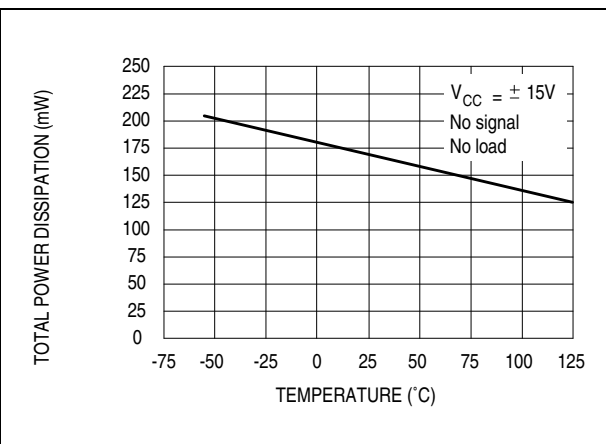

Figure 12. Supply current per amplifier versus free air temperature

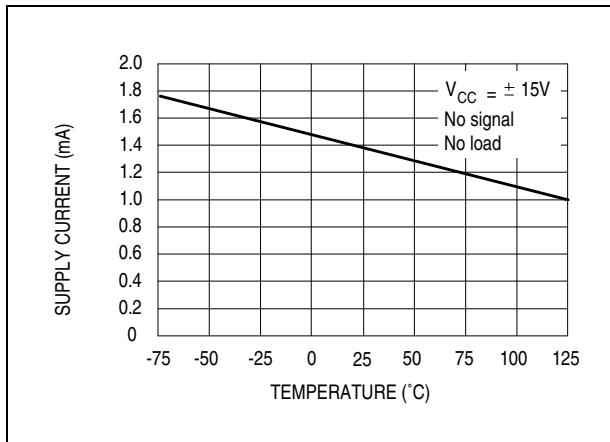

Figure 13. Supply current per amplifier versus supply voltage

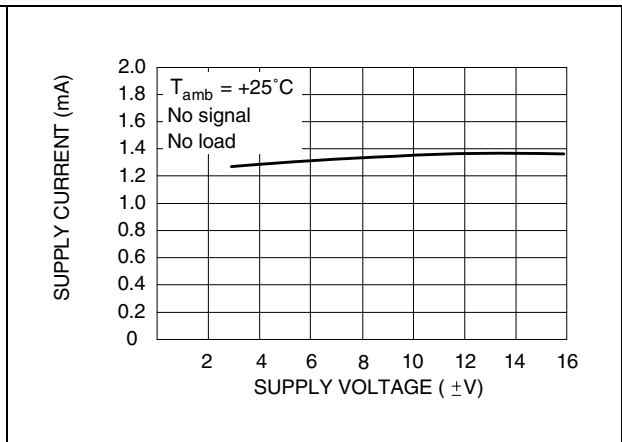

Figure 14. Common mode rejection ratio versus free air temperature

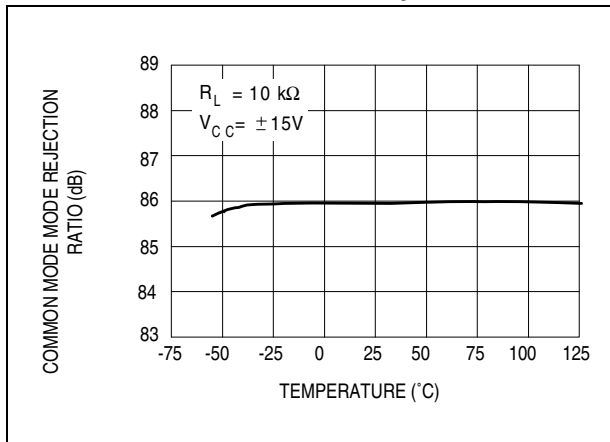

Figure 15. Voltage follower large signal pulse response

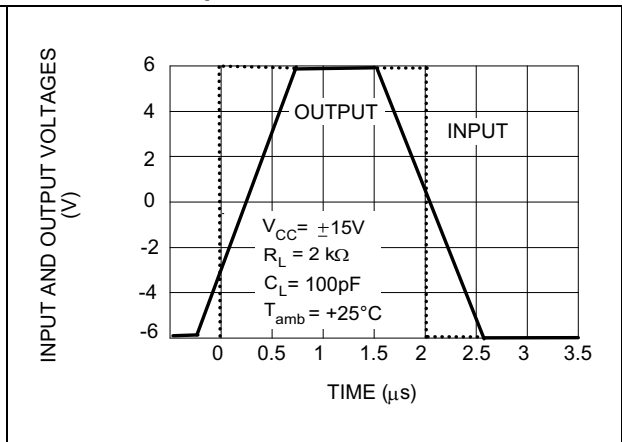

Figure 16. Output voltage versus elapsed time

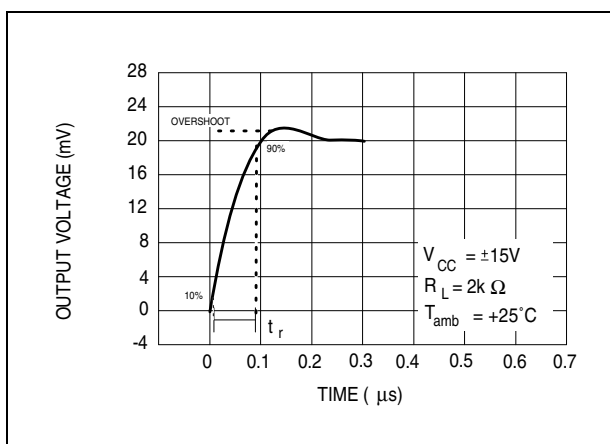

Figure 17. Equivalent input noise voltage versus frequency

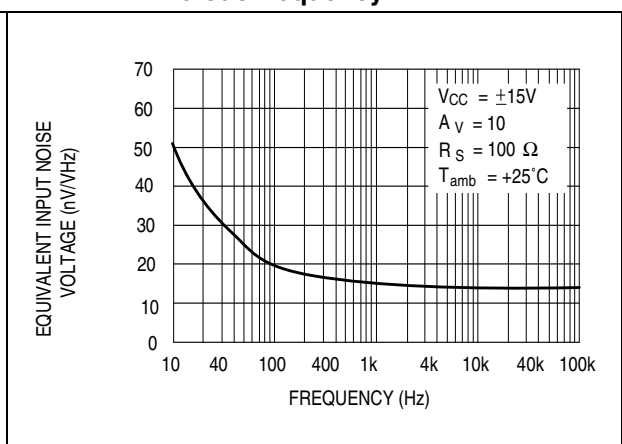
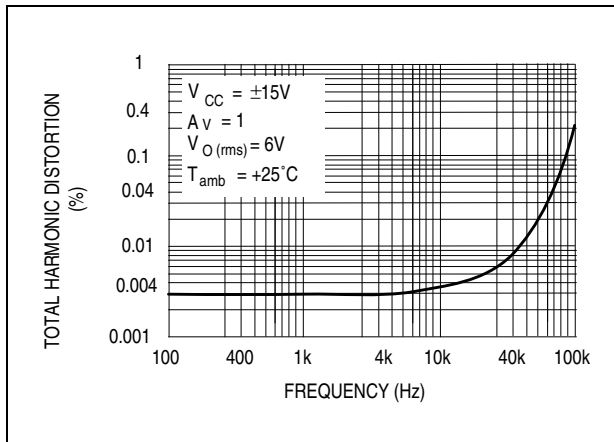

Figure 18. Total harmonic distortion versus frequency



4 Parameter measurement information

Figure 19. Voltage follower

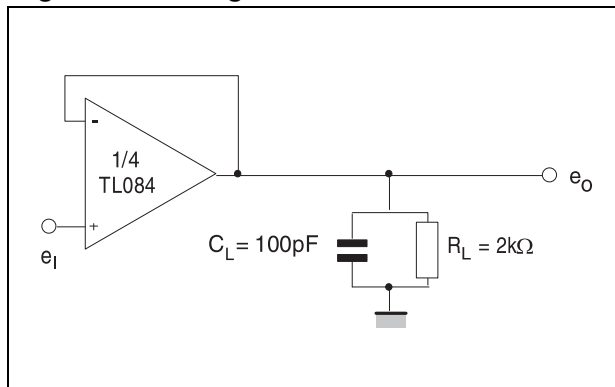
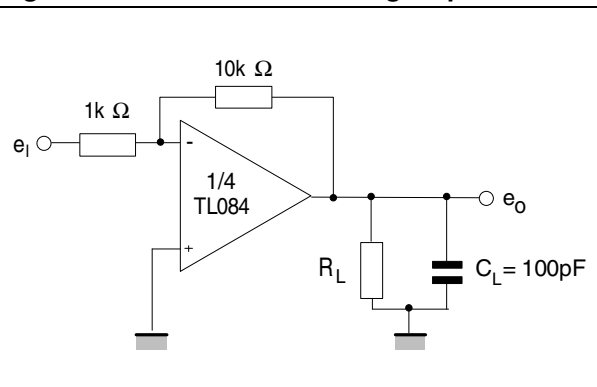

Figure 20. Gain-of-10 inverting amplifier



5 Typical applications

Figure 21. Audio distribution amplifier

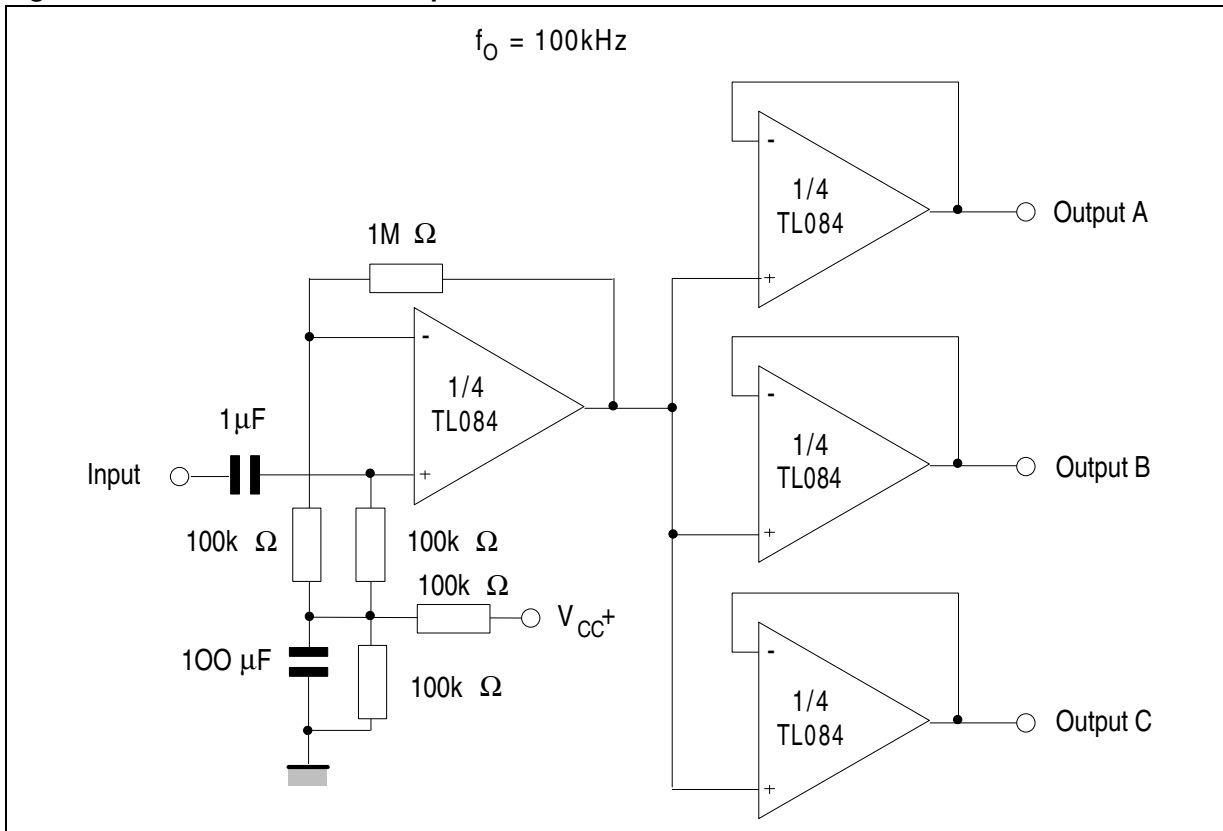

Figure 22. Positive feedback bandpass filter

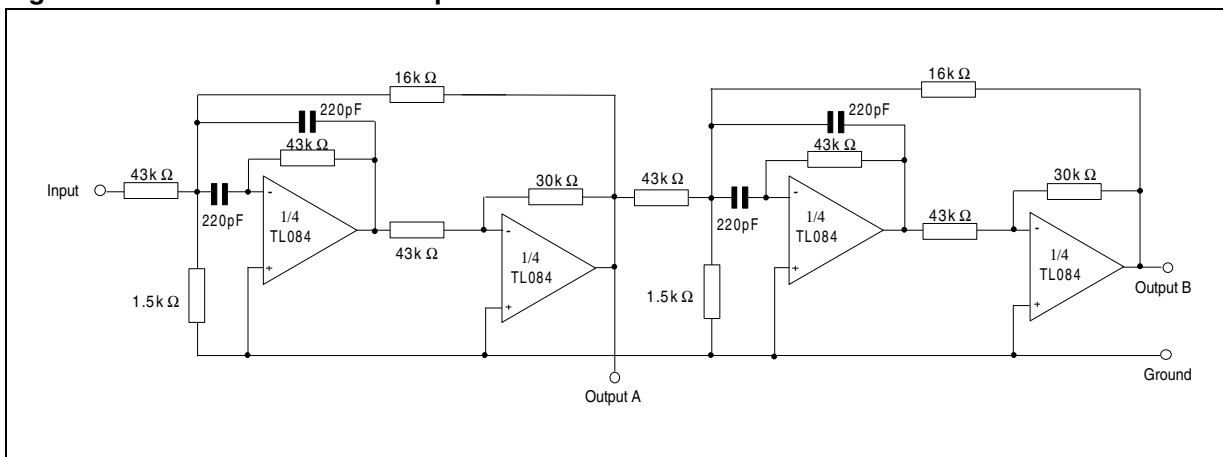
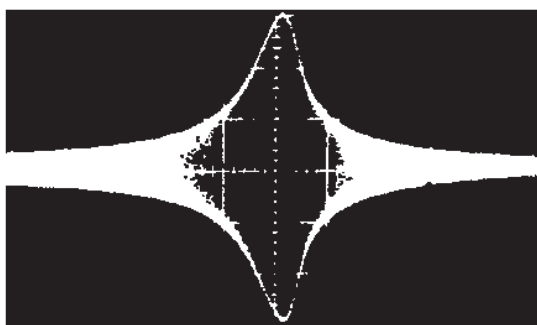
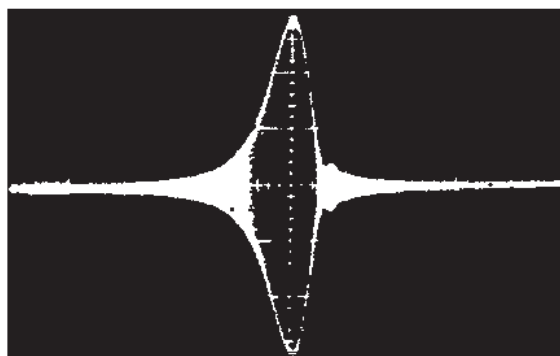

Figure 23. Output A



Second order bandpass filter
fo = 100 kHz; Q = 30; Gain = 4

Figure 24. Output B



Cascaded bandpass filter
fo = 100 kHz; Q = 69; Gain = 16

6 Package information

In order to meet environmental requirements, ST offers these devices in different grades of ECOPACK[®] packages, depending on their level of environmental compliance. ECOPACK[®] specifications, grade definitions and product status are available at: www.st.com. ECOPACK[®] is an ST trademark.

6.1 TSSOP14 package information

Figure 25. TSSOP14 package mechanical drawing

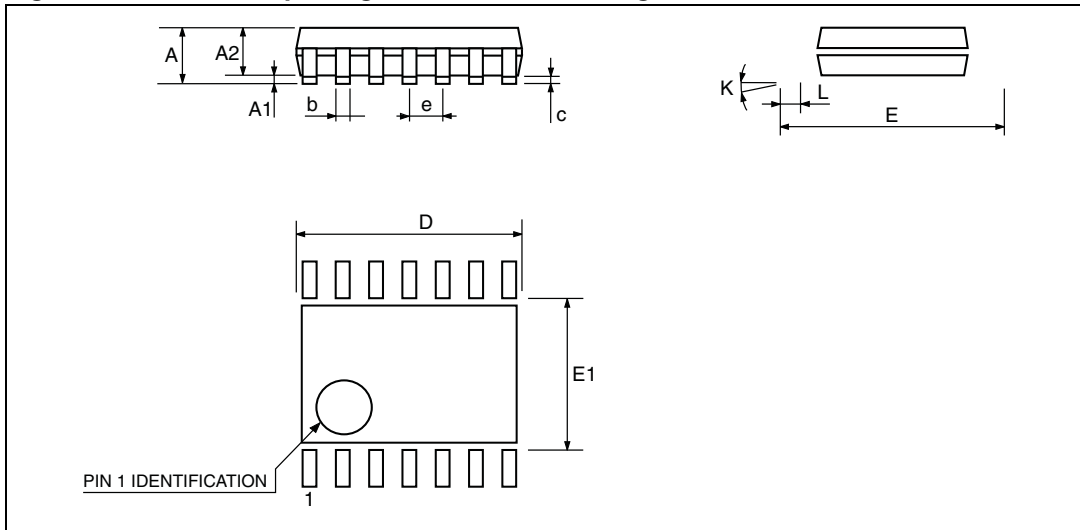

Figure 26. TSSOP14 package mechanical data

Ref.	Millimeters			Inches		
	Min.	Typ.	Max.	Min.	Typ.	Max.
A			1.2			0.047
A1	0.05		0.15	0.002	0.004	0.006
A2	0.8	1	1.05	0.031	0.039	0.041
b	0.19		0.30	0.007		0.012
c	0.09		0.20	0.004		0.0089
D	4.9	5	5.1	0.193	0.197	0.201
E	6.2	6.4	6.6	0.244	0.252	0.260
E1	4.3	4.4	4.48	0.169	0.173	0.176
e		0.65 BSC			0.0256 BSC	
K	0°		8°	0°		8°
L1	0.45	0.60	0.75	0.018	0.024	0.030

6.2 DIP14 package information

Figure 27. DIP14 package mechanical drawing

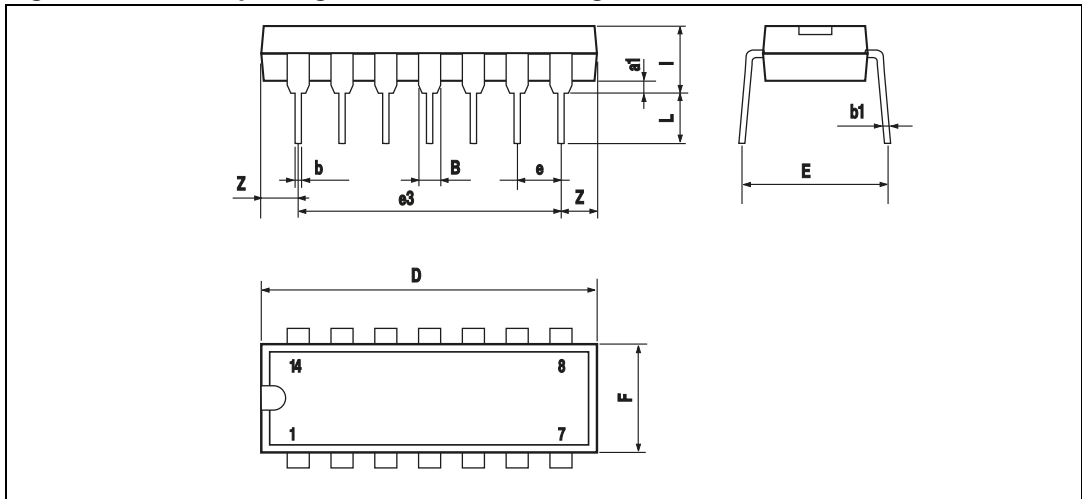

Table 4. DIP14 package mechanical data

Ref.	Dimensions					
	Millimeters			Inches		
	Min.	Typ.	Max.	Min.	Typ.	Max.
a1	0.51			0.020		
B	1.39		1.65	0.055		0.065
b		0.5			0.020	
b1		0.25			0.010	
D			20			0.787
E		8.5			0.335	
e		2.54			0.100	
e3		15.24			0.600	
F			7.1			0.280
l			5.1			0.201
L		3.3			0.130	
Z	1.27		2.54	0.050		0.100

6.3 SO-14 package information

Figure 28. SO-14 package mechanical drawing

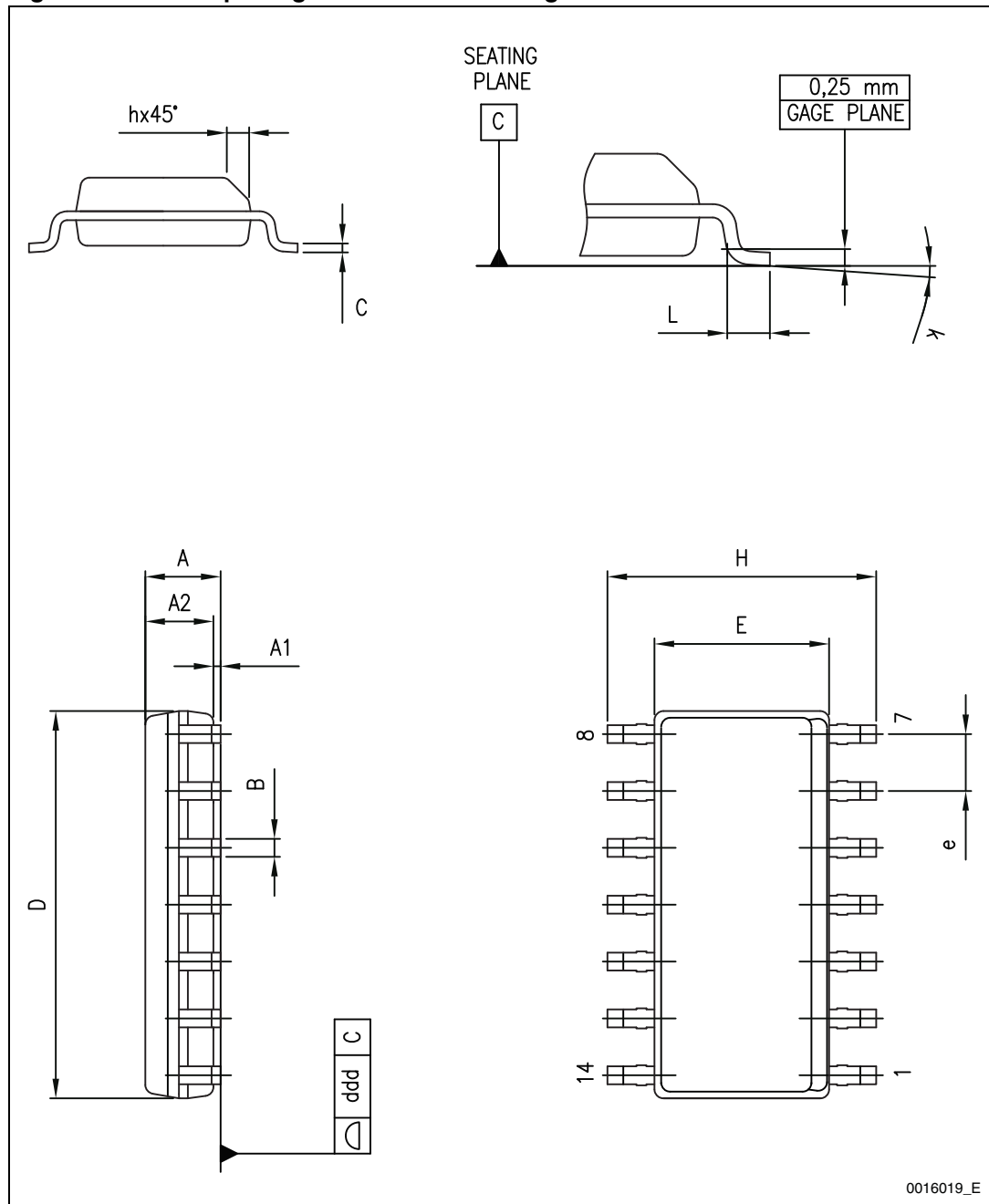

Table 5. SO-14 package mechanical data

Ref.	Dimensions					
	Millimeters			Inches		
	Min.	Typ.	Max.	Min.	Typ.	Max.
A			1.75			0.068
a1	0.1		0.2	0.003		0.007
a2			1.65			0.064
b	0.35		0.46	0.013		0.018
b1	0.19		0.25	0.007		0.010
C		0.5			0.019	
c1	45° (typ.)					
D	8.55		8.75	0.336		0.344
E	5.8		6.2	0.228		0.244
e		1.27			0.050	
e3		7.62			0.300	
F	3.8		4.0	0.149		0.157
G	4.6		5.3	0.181		0.208
L	0.5		1.27	0.019		0.050
M			0.68			0.026
S	8° (max.)					

7 Ordering information

Table 6. Order codes

Order code	Temperature range	Package	Packing	Marking
TL084IN TL084AIN TL084BIN	-40°C, +105°C	DIP14	Tube	TL084IN TL084AIN TL084BIN
TL084ID/IDT TL084AID/AIDT TL084BID/BIDT		SO-14	Tube or tape & reel	084I 084AI 084BI
TL084IYDT ⁽¹⁾ TL084AIYDT ⁽¹⁾ TL084BIYDT ⁽¹⁾		SO-14 (Automotive grade)	Tube or tape & reel	084IY 084AIY 084BIY
TL084IP/IPT TL084AIP/AIPT TL084BIP/BIPT		TSSOP14	Tube or tape & reel	084I 084AI 084BI
TL084CN TL084ACN TL084BCN	0°C, +70°C	DIP14	Tube	TL084CN TL084ACN TL084BCN
TL084CD/CDT TL084ACD/ACDT TL084BCD/BCDT		SO-14	Tube or tape & reel	084C 084AC 084BC
TL084CP/CPT TL084ACP/ACPT TL084BCP/BCPT		TSSOP14	Tube or tape & reel	084C 084AC 084BC

1. Qualification and characterization according to AEC Q100 and Q003 or equivalent, advanced screening according to AEC Q001 & Q 002 or equivalent.

8 Revision history

Table 7. Document revision history

Date	Revision	Changes
28-Mar-2001	1	Initial release.
30-Jul-2007	2	Added values for R_{thja} , R_{thjc} and ESD in Table 1: Absolute maximum ratings . Added Table 2: Operating conditions . Expanded Table 6: Order codes . Template update.
15-Jul-2008	3	Removed information concerning military temperature ranges (TL084Mx, TL084AMx, TL084BMx). Added automotive grade order codes in Table 6: Order codes .
05-Jul-2012	4	Removed commercial types TL084IYD, TL084AIYD and TL084BIYD. Updated Table 6: Order codes .

Please Read Carefully:

Information in this document is provided solely in connection with ST products. STMicroelectronics NV and its subsidiaries ("ST") reserve the right to make changes, corrections, modifications or improvements, to this document, and the products and services described herein at any time, without notice.

All ST products are sold pursuant to ST's terms and conditions of sale.

Purchasers are solely responsible for the choice, selection and use of the ST products and services described herein, and ST assumes no liability whatsoever relating to the choice, selection or use of the ST products and services described herein.

No license, express or implied, by estoppel or otherwise, to any intellectual property rights is granted under this document. If any part of this document refers to any third party products or services it shall not be deemed a license grant by ST for the use of such third party products or services, or any intellectual property contained therein or considered as a warranty covering the use in any manner whatsoever of such third party products or services or any intellectual property contained therein.

UNLESS OTHERWISE SET FORTH IN ST'S TERMS AND CONDITIONS OF SALE ST DISCLAIMS ANY EXPRESS OR IMPLIED WARRANTY WITH RESPECT TO THE USE AND/OR SALE OF ST PRODUCTS INCLUDING WITHOUT LIMITATION IMPLIED WARRANTIES OF MERCHANTABILITY, FITNESS FOR A PARTICULAR PURPOSE (AND THEIR EQUIVALENTS UNDER THE LAWS OF ANY JURISDICTION), OR INFRINGEMENT OF ANY PATENT, COPYRIGHT OR OTHER INTELLECTUAL PROPERTY RIGHT.

UNLESS EXPRESSLY APPROVED IN WRITING BY TWO AUTHORIZED ST REPRESENTATIVES, ST PRODUCTS ARE NOT RECOMMENDED, AUTHORIZED OR WARRANTED FOR USE IN MILITARY, AIR CRAFT, SPACE, LIFE SAVING, OR LIFE SUSTAINING APPLICATIONS, NOR IN PRODUCTS OR SYSTEMS WHERE FAILURE OR MALFUNCTION MAY RESULT IN PERSONAL INJURY, DEATH, OR SEVERE PROPERTY OR ENVIRONMENTAL DAMAGE. ST PRODUCTS WHICH ARE NOT SPECIFIED AS "AUTOMOTIVE GRADE" MAY ONLY BE USED IN AUTOMOTIVE APPLICATIONS AT USER'S OWN RISK.

Resale of ST products with provisions different from the statements and/or technical features set forth in this document shall immediately void any warranty granted by ST for the ST product or service described herein and shall not create or extend in any manner whatsoever, any liability of ST.

ST and the ST logo are trademarks or registered trademarks of ST in various countries.

Information in this document supersedes and replaces all information previously supplied.

The ST logo is a registered trademark of STMicroelectronics. All other names are the property of their respective owners.

© 2012 STMicroelectronics - All rights reserved

STMicroelectronics group of companies

Australia - Belgium - Brazil - Canada - China - Czech Republic - Finland - France - Germany - Hong Kong - India - Israel - Italy - Japan - Malaysia - Malta - Morocco - Philippines - Singapore - Spain - Sweden - Switzerland - United Kingdom - United States of America

www.st.com