

Micropower, Dual and Quad, Single Supply, Precision Op Amps

FEATURES

- Available in 8-Pin SO Package
- 50 μ A Max Supply Current Per Amplifier
- 70 μ V Max Offset Voltage
- 180 μ V Max Offset Voltage in 8-Pin SO
- 250pA Max Offset Current
- 0.6 μ Vp-p 0.1Hz to 10Hz Voltage Noise
- 3pAp-p 0.1Hz to 10Hz Current Noise
- 0.4 μ V/ $^{\circ}$ C Offset Voltage Drift
- 200kHz Gain-Bandwidth Product
- 0.07V/ μ s Slew Rate
- Single Supply Operation
 - Input Voltage Range Includes Ground
 - Output Swings to Ground While Sinking Current
 - No Pull Down Resistors Needed
- Output Sources and Sinks 5mA Load Current

APPLICATIONS

- Battery or Solar Powered Systems
 - Portable Instrumentation
 - Remote Sensor Amplifier
 - Satellite Circuitry
- Micropower Sample-and-Hold
- Thermocouple Amplifier
- Micropower Filters

DESCRIPTION

The LT1078 is a micropower dual op amp in 8-pin packages including the small outline surface mount package. The LT1079 is a micropower quad op amp offered in the standard 14-pin packages. Both devices are optimized for single supply operation at 5V. ± 15 V specifications are also provided.

Micropower performance of competing devices is achieved at the expense of seriously degrading precision, noise, speed, and output drive specifications. The design effort of the LT1078/1079 was concentrated on reducing supply current without sacrificing other parameters. The offset voltage achieved is the lowest on any dual or quad non-chopper stabilized op amp — micropower or otherwise. Offset current, voltage and current noise, slew rate and gain-bandwidth product are all two to ten times better than on previous micropower op amps.

The 1/f corner of the voltage noise spectrum is at 0.7Hz, at least three times lower than on any monolithic op amp. This results in low frequency (0.1Hz to 10Hz) noise performance which can only be found on devices with an order of magnitude higher supply current.

Both the LT1078 and LT1079 can be operated from a single supply (as low as one lithium cell or two Ni-cad batteries). The input range goes below ground. The all-NPN output stage swings to within a few millivolts of ground while sinking current — no power consuming pull down resistors are needed.

Single Battery, Micropower, Gain = 100, Instrumentation Amplifier

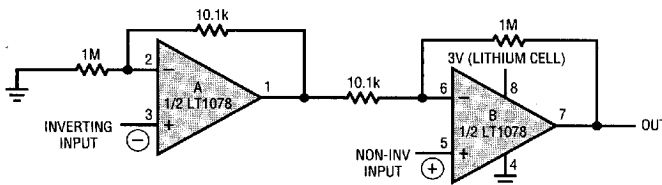

TYPICAL PERFORMANCE

INPUT OFFSET VOLTAGE = 40 μ V
 INPUT OFFSET CURRENT = 0.2nA
 TOTAL POWER DISSIPATION = 240 μ W
 COMMON-MODE REJECTION = 110dB (AMPLIFIER LIMITED)
 GAIN-BANDWIDTH PRODUCT = 200kHz

OUTPUT NOISE = 85 μ Vp-p 0.1Hz TO 10Hz
 = 300 μ V_{RMS} OVER FULL BANDWIDTH
 INPUT RANGE = 0.03V TO 1.8V
 OUTPUT RANGE = 0.03V TO 2.3V
 (0.3mV \leq $V_{IN} - V_{IN-}$ \leq 23mV)
 OUTPUTS SINK CURRENT — NO PULL DOWN RESISTORS
 ARE NEEDED

LT1078-TA01

Distribution of Input Offset Voltage (LT1078 and LT1079 in H, J, N Packages)

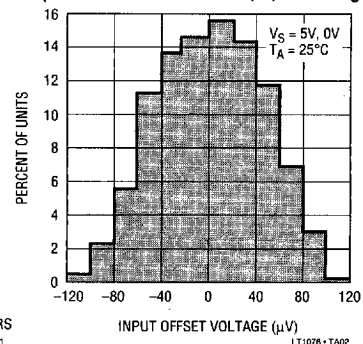

LT1078/LT1079

ABSOLUTE MAXIMUM RATINGS

Supply Voltage	±22V	Operating Temperature Range	
Differential Input Voltage	±30V	LT1078AM/LT1078M/	
Input Voltage	Equal to Positive Supply Voltage	LT1079AM/LT1079M	-55°C to 125°C
	5V Below Negative Supply Voltage	LT1078I/LT1079I	-40°C to 85°C
Output Short Circuit Duration	Indefinite	LT1078AC/LT1078C/LT1078S8/	
Storage Temperature Range		LT1079AC/LT1079C	0°C to 70°C
All Grades	- 65°C to 150°C	Lead Temperature (Soldering, 10 sec.)	300°C

PACKAGE/ORDER INFORMATION

<p>TOP VIEW</p> <p>V+ OUT A 1 -IN A 2 +IN A 3 V- (CASE) 4 -IN B 5 +IN B 6 OUT B 7 OUT C 8</p> <p>H PACKAGE 8-LEAD TO-S METAL CAN</p> <p>LT1078 - PO101</p> <p>$T_{JMAX} = 150^{\circ}\text{C}$, $\theta_{JA} = 150^{\circ}\text{C/W}$, $\theta_{JC} = 45^{\circ}\text{C/W}$</p>	<p>TOP VIEW</p> <p>OUT A 1 -IN A 2 +IN A 3 V- 4 V+ 8 OUT B 7 -IN B 6 +IN B 5</p> <p>J8 PACKAGE 8-LEAD CERAMIC DIP N8 PACKAGE 8-LEAD PLASTIC DIP</p> <p>LT1078 - PO102</p> <p>$T_{JMAX} = 150^{\circ}\text{C}$, $\theta_{JA} = 100^{\circ}\text{C/W}$ (J8) $T_{JMAX} = 100^{\circ}\text{C}$, $\theta_{JA} = 130^{\circ}\text{C/W}$ (N8)</p>	<p>TOP VIEW</p> <p>OUT A 1 -IN A 2 +IN A 3 V+ 4 -IN B 5 +IN B 6 OUT B 7 OUT D 14 -IN D 13 +IN D 12 V- 11 +IN C 10 -IN C 9 OUT C 8</p> <p>J PACKAGE 14-LEAD CERAMIC DIP N PACKAGE 14-LEAD PLASTIC DIP</p> <p>LT1078 - PO103</p> <p>$T_{JMAX} = 150^{\circ}\text{C}$, $\theta_{JA} = 100^{\circ}\text{C/W}$ (J) $T_{JMAX} = 110^{\circ}\text{C}$, $\theta_{JA} = 130^{\circ}\text{C/W}$ (N)</p>
ORDER PART NUMBER	ORDER PART NUMBER	ORDER PART NUMBER
LT1078AMH LT1078MH LT1078ACH LT1078CH	LT1078AMJ8 LT1078ACN8 LT1078MJ8 LT1078CN8 LT1078ACJ8 LT1078IN8 LT1078CJ8	LT1079AMJ LT1079ACN LT1079MJ8 LT1079CN LT1079ACJ LT1079IN LT1079CJ
<p>TOP VIEW</p> <p>+IN A 1 V- 2 +IN B 3 -IN B 4 -IN A 8 -IN A 7 OUT A 7 V+ 6 OUT B 5</p> <p>S8 PACKAGE 8-LEAD PLASTIC SOIC</p> <p>NOTE: THIS PIN CONFIGURATION DIFFERS FROM THE 8-LEAD DIP PIN LOCATIONS. INSTEAD, IT FOLLOWS THE INDUSTRY STANDARD LT1013DS8 SO PACKAGE CONFIGURATION.</p> <p>LT1078 - PO104</p> <p>$T_{JMAX} = 110^{\circ}\text{C}$, $\theta_{JA} = 220^{\circ}\text{C/W}$</p>		<p>TOP VIEW</p> <p>OUT A 1 -IN A 2 +IN A 3 V+ 4 -IN B 5 +IN B 6 OUT B 7 NC 8 OUT D 16 -IN D 15 +IN D 14 V- 13 +IN C 12 -IN C 11 OUT C 10 NC 9</p> <p>S PACKAGE 16-LEAD PLASTIC SOL</p> <p>LT1078 - PO106</p> <p>$T_{JMAX} = 110^{\circ}\text{C}$, $\theta_{JA} = 150^{\circ}\text{C/W}$</p>
ORDER PART NUMBER	PART MARKING	ORDER PART NUMBER
LT1078IS8 LT1078S8	1078	LT1079IS LT1079S

ELECTRICAL CHARACTERISTICS

$V_S = 5V, 0V, V_{CM} = 0.1V, V_O = 1.4V, T_A = 25^\circ C$, unless otherwise noted.

SYMBOL	PARAMETER	CONDITIONS (Note 1)	LT1078AM/AC LT1079AM/AC			LT1078M/C/I/S LT1079M/C/I/S			UNITS
			MIN	TYP	MAX	MIN	TYP	MAX	
V_{OS}	Input Offset Voltage	LT1078	30	70		40	120		μV
		LT1078IS8/LT1078S8				60	180		μV
		LT1079	35	100		40	150		μV
		LT1079IS/S				60	300		μV
$\frac{\Delta V_{OS}}{\Delta Time}$	Long Term Input Offset Voltage Stability		0.4		0.5			$\mu V/Mo$	
I_{OS}	Input Offset Current		0.05	0.25	0.05	0.35		nA	
I_B	Input Bias Current		6	8	6	10		nA	
e_n	Input Noise Voltage	0.1Hz to 10Hz (Note 2)	0.6	1.2	0.6			$\mu Vp-p$	
	Input Noise Voltage Density	$f_0 = 10Hz$ (Note 2)	29	45	29			nV/\sqrt{Hz}	
		$f_0 = 1000Hz$ (Note 2)	28	37	28			nV/\sqrt{Hz}	
i_n	Input Noise Current	0.1Hz to 10Hz (Note 2)	2.3	4.0	2.3			$pAp-p$	
	Input Noise Current Density	$f_0 = 10Hz$ (Note 2)	0.06	0.10	0.06			pA/\sqrt{Hz}	
		$f_0 = 1000Hz$	0.02		0.02			pA/\sqrt{Hz}	
	Input Resistance Differential Mode Common-Mode	(Note 3)	400	800	300	800		$M\Omega$	
			6		6			$G\Omega$	
	Input Voltage Range		3.5	3.8	3.5	3.8		V	
			0	-0.3	0	-0.3		V	
CMRR	Common-Mode Rejection Ratio	$V_{CM} = 0V$ to 3.5V	97	110	94	108		dB	
PSRR	Power Supply Rejection Ratio	$V_S = 2.3V$ to 12V	102	114	100	114		dB	
A_{VOL}	Large Signal Voltage Gain	$V_O = 0.03V$ to 4V, No Load	200	1000	150	1000		V/mV	
		$V_O = 0.03V$ to 3.5V, $R_L = 50k$	150	600	120	600		V/mV	
	Maximum Output Voltage Swing	Output Low, No Load	3.5	6	3.5	6		mV	
		Output Low, 2k to GND	0.55	1.0	0.55	1.0		mV	
		Output Low, $I_{SINK} = 100\mu A$	95	130	95	130		mV	
		Output High, No Load	4.2	4.4	4.2	4.4		V	
			3.5	3.9	3.5	3.9		V	
SR	Slew Rate	$A_V = +1, V_S = \pm 2.5V$	0.04	0.07	0.04	0.07		V/ μs	
GBW	Gain-Bandwidth Product	$f_0 \leq 20kHz$	200		200			kHz	
I_S	Supply Current Per Amplifier		38	50	39	55		μA	
	Channel Separation	$\Delta V_{IN} = 3V, R_L = 10k$	130		130			dB	
	Minimum Supply Voltage	(Note 4)	2.2	2.3	2.2	2.3		V	

LT1078/LT1079

ELECTRICAL CHARACTERISTICS

$V_S = 5V, 0V, V_{CM} = 0.1V, V_O = 1.4V, -40^\circ C \leq T_A \leq 85^\circ C$ for I grades, $-55^\circ C \leq T_A \leq 125^\circ C$ for AM/M grades, unless otherwise noted.

SYMBOL	PARAMETER	CONDITIONS		LT1078AM LT1079AM			LT1078M/ LT1079M/I			UNITS
				MIN	TYP	MAX	MIN	TYP	MAX	
V_{OS}	Input Offset Voltage	LT1078 LT1079, LT1078IS8 LT1079IS	●	70	250	95	370	μV		
			●	80	280	100	400	μV		
			●			100	560	μV		
$\frac{\Delta V_{OS}}{\Delta T}$	Input Offset Voltage Drift (Note 5)	LT1078IS8 LT1078IS16, LT1079IS	●	0.4	1.8	0.5	2.5	$\mu V/^\circ C$		
			●			0.6	3.5	$\mu V/^\circ C$		
			●			0.7	4.0	$\mu V/^\circ C$		
I_{OS}	Input Offset Current	LT1078I, LT1079I	●	0.07	0.50	0.07	0.70	nA		
			●			0.1	1.0	nA		
I_B	Input Bias Current		●	7	10	7	12	nA		
CMRR	Common-Mode Rejection Ratio	$V_{CM} = 0.05V$ to $3.2V$	●	92	106	88	104	dB		
PSRR	Power Supply Rejection Ratio	$V_S = 3.1V$ to $12V$	●	98	110	94	110	dB		
A_{VOL}	Large Signal Voltage Gain	$V_O = 0.05V$ to $4V$, No Load $V_O = 0.05V$ to $3.5V, R_L = 50k$	●	110	600	80	600	V/mV		
			●	80	400	60	400	V/mV		
	Maximum Output Voltage Swing	Output Low, No Load Output Low, $I_{SINK} = 100\mu A$	●	4.5	8	4.5	8	mV		
			●	125	170	125	170	mV		
		Output High, No Load Output High, $2k$ to GND	●	3.9	4.2	3.9	4.2	V		
			●	3.0	3.7	3.0	3.7	V		
I_S	Supply Current Per Amplifier		●	43	60	45	70	μA		

ELECTRICAL CHARACTERISTICS

$V_S = 5V, 0V, V_{CM} = 0.1V, V_O = 1.4V, 0^\circ C \leq T_A \leq 70^\circ C$, unless otherwise noted.

SYMBOL	PARAMETER	CONDITIONS		LT1078AC LT1079AC			LT1078C/S LT1079C/S			UNITS
				MIN	TYP	MAX	MIN	TYP	MAX	
V_{OS}	Input Offset Voltage	LT1078 LT1079 LT1078S8 LT1079S	●	50	150	60	240	μV		
			●	60	180	70	270	μV		
			●			85	350	μV		
			●			90	480	μV		
$\frac{\Delta V_{OS}}{\Delta T}$	Input Offset Voltage Drift (Note 5)	LT1078S8 LT1078S16, LT1079S	●	0.4	1.8	0.5	2.5	$\mu V/^\circ C$		
			●			0.6	3.5	$\mu V/^\circ C$		
			●			0.7	4.0	$\mu V/^\circ C$		
I_{OS}	Input Offset Current		●	0.06	0.35	0.06	0.50	nA		
I_B	Input Bias Current		●	6	9	6	11	nA		
CMRR	Common-Mode Rejection Ratio	$V_{CM} = 0V$ to $3.4V$	●	94	108	90	106	dB		
PSRR	Power Supply Rejection Ratio	$V_S = 2.6V$ to $12V$	●	100	112	97	112	dB		
A_{VOL}	Large Signal Voltage Gain	$V_O = 0.05V$ to $4V$, No Load $V_O = 0.05V$ to $3.5V, R_L = 50k$	●	150	750	110	750	V/mV		
			●	110	500	80	500	V/mV		
	Maximum Output Voltage Swing	Output Low, No Load Output Low, $I_{SINK} = 100\mu A$	●	4.0	7	4.0	7	mV		
			●	105	150	105	150	mV		
		Output High, No Load Output High, $2k$ to GND	●	4.1	4.3	4.1	4.3	V		
			●	3.3	3.8	3.3	3.8	V		
I_S	Supply Current Per Amplifier		●	40	55	42	63	μA		

ELECTRICAL CHARACTERISTICS $V_S = \pm 15V$, $T_A = 25^\circ C$, unless otherwise noted.

SYMBOL	PARAMETER	CONDITIONS	LT1078AM/AC LT1079AM/AC			LT1078M/C/I/S LT1079M/C/I/S			UNITS
			MIN	TYP	MAX	MIN	TYP	MAX	
V_{OS}	Input Offset Voltage	(Including LT1078IS8/S8) LT1079IS/S		50	250		70 80	350 500	μV μV
I_{OS}	Input Offset Current			0.05	0.25		0.05	0.35	nA
I_B	Input Bias Current			6	8		6	10	nA
	Input Voltage Range		13.5 -15.0	13.8 -15.3		13.5 -15.0	13.8 -15.3		V V
CMRR	Common-Mode Rejection Ratio	$V_{CM} = +13.5V, -15V$	100	114		97	114		dB
PSRR	Power Supply Rejection Ratio	$V_S = 5V, 0V$ to $\pm 18V$	102	114		100	114		dB
A_{VOL}	Large Signal Voltage Gain	$V_O = \pm 10V, R_L = 50k$ $V_O = \pm 10V, R_L = 2k$	1000 400	5000 1100		1000 300	5000 1100		V/mV V/mV
V_{OUT}	Maximum Output Voltage Swing	$R_L = 50k$ $R_L = 2k$	± 13.0 ± 11.0	± 14.0 ± 13.2		± 13.0 ± 11.0	± 14.0 ± 13.2		V V
SR	Slew Rate		0.06	0.10		0.06	0.10		V/ μs
I_S	Supply Current Per Amplifier			46	65		47	75	μA

ELECTRICAL CHARACTERISTICS

$V_S = \pm 15V$, $-40^\circ C \leq T_A \leq 85^\circ C$ for I grades, $-55^\circ C \leq T_A \leq 125^\circ C$ for AM/M grades, unless otherwise noted.

SYMBOL	PARAMETER	CONDITIONS	LT1078AM LT1079AM			LT1078M/I LT1079M/I			UNITS
			MIN	TYP	MAX	MIN	TYP	MAX	
V_{OS}	Input Offset Voltage	(Including LT1078IS8) LT1079IS		90	430		120 130	600 825	μV μV
$\frac{\Delta V_{OS}}{\Delta T}$	Input Offset Voltage Drift (Note 5)	LT1078IS8 LT1078IS16, LT1079IS		0.5	1.8		0.6 0.7 0.8	2.5 3.8 5.0	$\mu V/^\circ C$ $\mu V/^\circ C$ $\mu V/^\circ C$
I_{OS}	Input Offset Current	LT1078I, LT1079I		0.07	0.50		0.07 0.1	0.70 1.0	nA nA
I_B	Input Bias Current			7	10		7	12	nA
A_{VOL}	Large Signal Voltage Gain	$V_O = \pm 10V, R_L = 5k$		200	700		150	700	V/mV
CMRR	Common-Mode Rejection Ratio	$V_{CM} = +13V, -14.9V$		94	110		90	110	dB
PSRR	Power Supply Rejection Ratio	$V_S = 5V, 0V$ to $\pm 18V$		98	110		94	110	dB
	Maximum Output Voltage Swing	$R_L = 5k$		± 11.0	± 13.5		± 11.0	± 13.5	V
I_S	Supply Current Per Amplifier			52	80		54	95	μA



5518468 0014121 904

ELECTRICAL CHARACTERISTICS $V_S = \pm 15V, 0^\circ C \leq T_A \leq 70^\circ C$, unless otherwise noted.

SYMBOL	PARAMETER	CONDITIONS	LT1078AC LT1079AC			LT1078C/S LT1079C/S			UNITS
			MIN	TYP	MAX	MIN	TYP	MAX	
V_{OS}	Input Offset Voltage	LT1078S8 LT1079S	●	70	330	90	460	μV	
			●			100	540	μV	
			●			115	750	μV	
$\frac{\Delta V_{OS}}{\Delta T}$	Input Offset Voltage Drift (Note 5)	LT1078S8 LT1079S	●	0.5	1.8	0.6	2.5	$\mu V/^\circ C$	
			●			0.7	3.8	$\mu V/^\circ C$	
			●			0.8	5.0	$\mu V/^\circ C$	
I_{OS}	Input Offset Current		●	0.06	0.35	0.06	0.50	nA	
I_B	Input Bias Current		●	6	9	6	11	nA	
A_{VOL}	Large Signal Voltage Gain	$V_O = \pm 10V, R_L = 5k$	●	300	1200	250	1200	V/mV	
CMRR	Common-Mode Rejection Ratio	$V_{CM} = 13V, -15V$	●	97	112	94	112	dB	
PSRR	Power Supply Rejection Ratio	$V_S = 5V, 0V$ to $\pm 18V$	●	100	112	97	112	dB	
	Maximum Output Voltage Swing	$R_L = 5k$	●	± 11.0	± 13.6	± 11.0	± 13.6	V	
I_S	Supply Current Per Amplifier		●	49	73	50	85	μA	

The ● denotes the specifications which apply over the full operating temperature range.

Note 1: Typical parameters are defined as the 60% yield of parameter distributions of individual amplifiers; i.e., out of 100 LT1079s (or 100 LT1078s) typically 240 op amps (or 120) will be better than the indicated specification.

Note 2: This parameter is tested on a sample basis only. All noise parameters are tested with $V_S = \pm 2.5V, V_O = 0V$.

Note 3: This parameter is guaranteed by design and is not tested.

Note 4: Power supply rejection ratio is measured at the minimum supply voltage. The op amps actually work at 1.8V supply but with a typical offset skew of $-300\mu V$.

Note 5: This parameter is not 100% tested.

TYPICAL PERFORMANCE CHARACTERISTICS

Supply Current vs Temperature

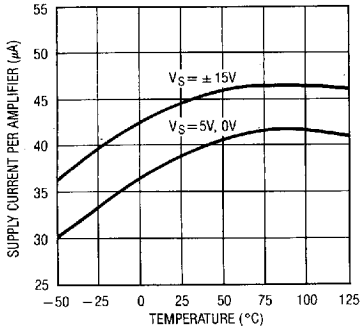

Input Bias and Offset Currents vs Temperature

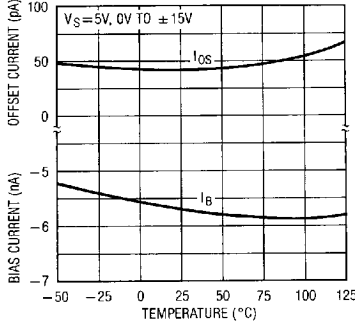

Input Bias Current vs Common-Mode Voltage

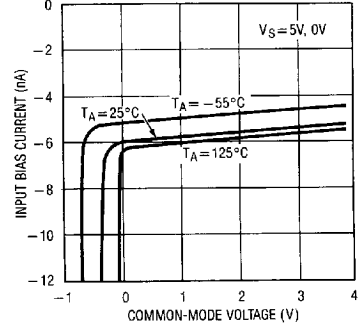

0.1Hz to 10Hz Noise

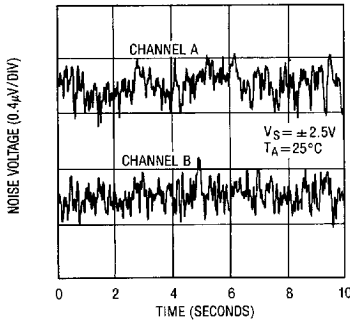

0.01Hz to 10Hz Noise

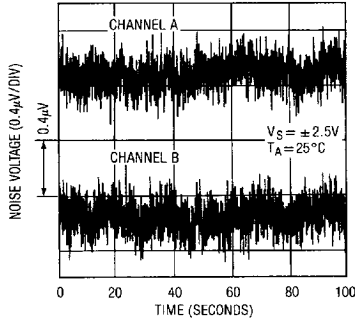

Noise Spectrum

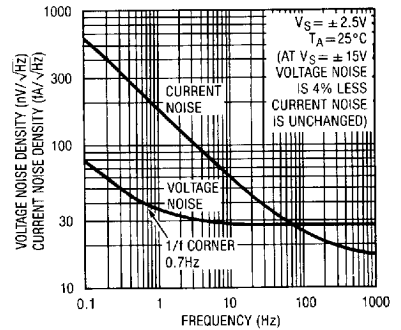

10Hz Voltage Noise Distribution

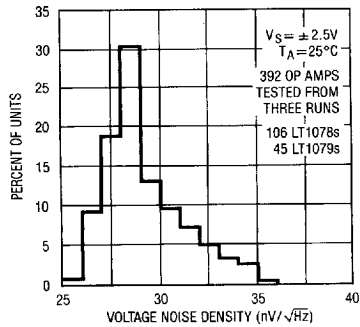

Distribution of Offset Voltage Drift with Temperature (In All Packages Except Surface Mount)

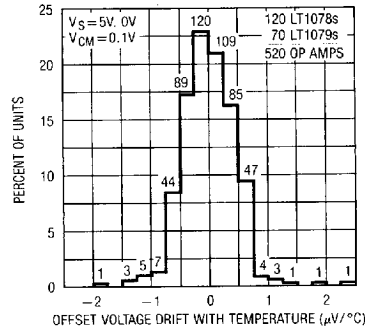

Long Term Stability of Two Representative Units (LT1078)

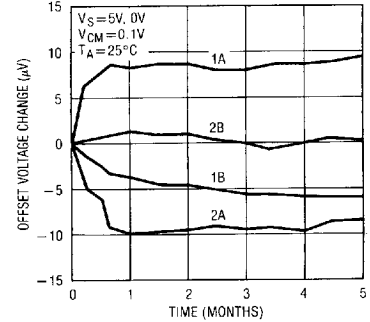

5518468 0014123 787

TYPICAL PERFORMANCE CHARACTERISTICS

Voltage Gain vs Frequency

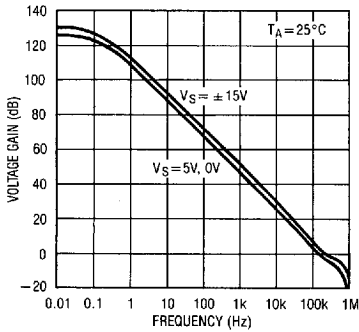

Gain, Phase vs Frequency

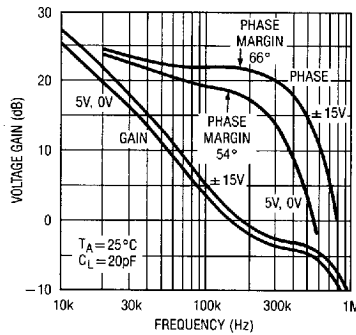

Capacitive Load Handling

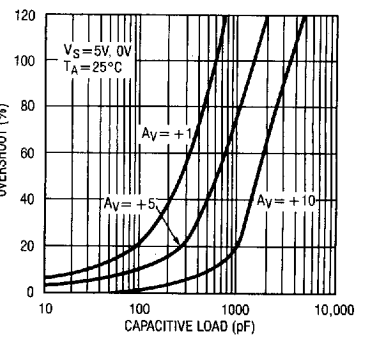

Slew Rate, Gain Bandwidth Product and Phase Margin vs Temperature

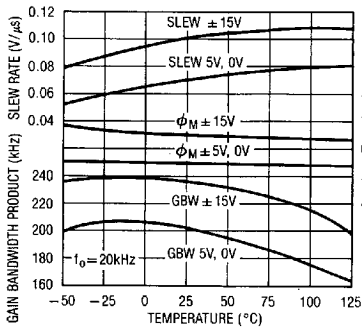

Large Signal Transient Response VS = 5V, 0V

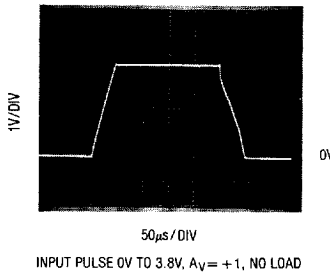

Large Signal Transient Response VS = ±15V

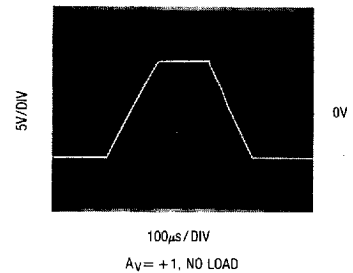

Minimum Supply Voltage

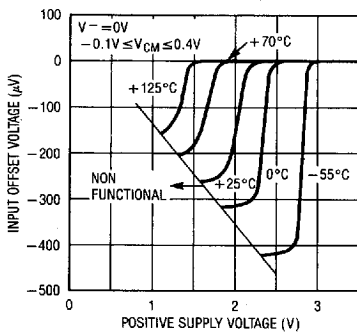

Warm-Up Drift

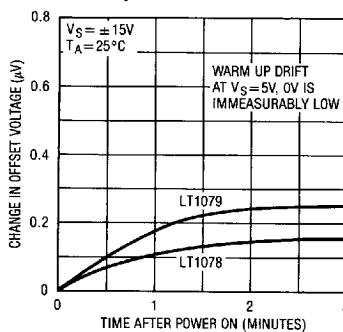

Voltage Gain vs Load Resistance

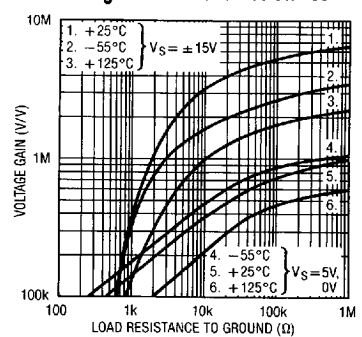

TYPICAL PERFORMANCE CHARACTERISTICS

Output Saturation vs Temperature vs Sink Current

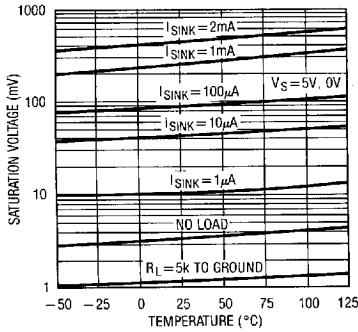

Output Voltage Swing vs Load Current

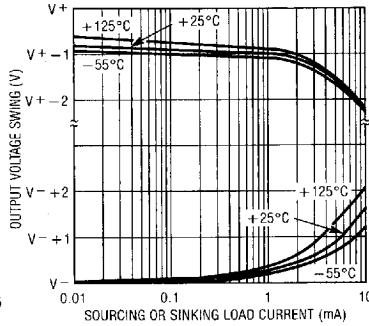

Distribution of Input Offset Voltage (LT1078 in 8-Pin SO Package)

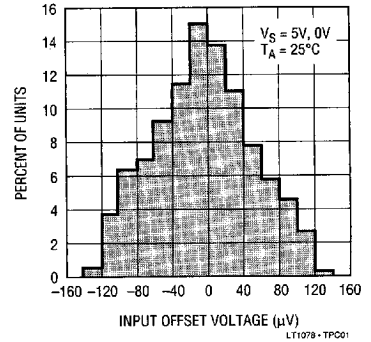

Common Mode Range vs Temperature

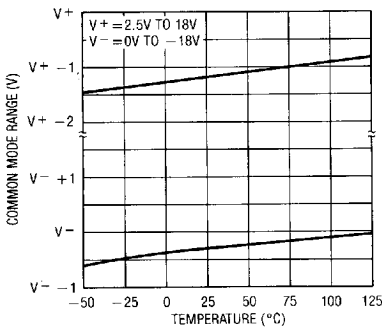

Undistorted Output Swing vs Frequency

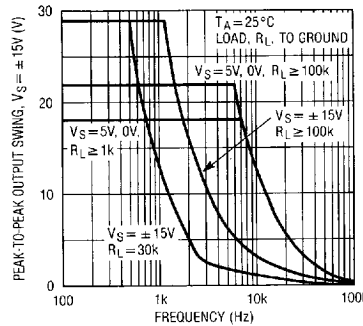

Closed Loop Output Impedance

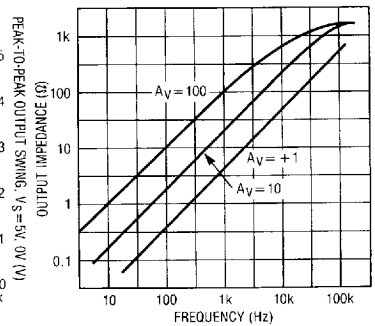

Common-Mode Rejection Ratio vs Frequency

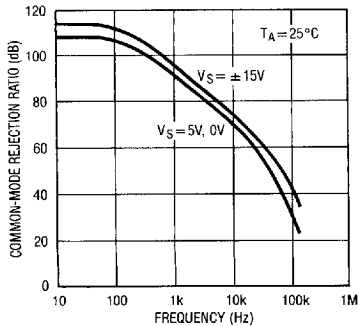

Power Supply Rejection Ratio vs Frequency

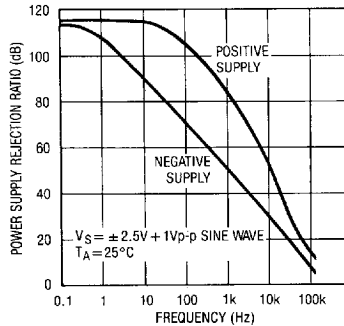

Channel Separation vs Frequency

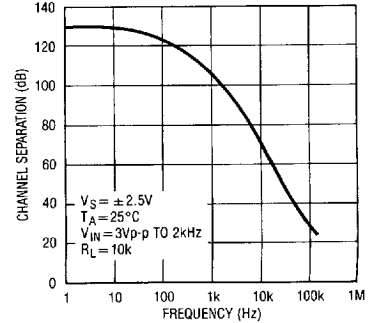

TYPICAL PERFORMANCE CHARACTERISTICS

Small Signal Transient Response
 $V_S = 5V, 0V$

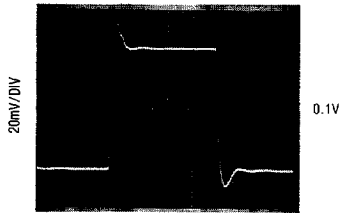

10µs/DIV
 $A_V = +1, C_L = 15pF, INPUT 50mV TO 150mV$

Small Signal Transient Response
 $V_S = \pm 2.5V$

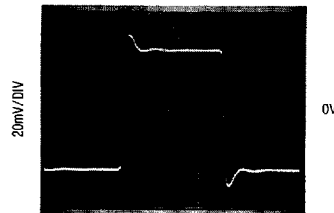

10µs/DIV
 $A_V = +1, C_L = 15pF$

Small Signal Transient Response
 $V_S = \pm 15V$

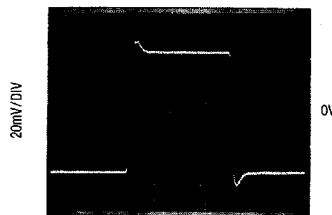

10µs/DIV
 $A_V = +1, C_L = 15pF$

APPLICATIONS INFORMATION

The LT1078/LT1079 devices are fully specified with $V^+ = 5V, V^- = 0, V_{CM} = 0.1V$. This set of operating conditions appears to be the most representative for battery powered micropower circuits. Offset voltage is internally trimmed to a minimum value at these supply voltages. When 9V or 3V batteries or $\pm 2.5V$ dual supplies are used, bias and offset current changes will be minimal. Offset voltage changes will be just a few microvolts as given by the PSRR and CMRR specifications. For example, if $PSRR = 114dB (= 2\mu V/V)$, at 9V the offset voltage change will be $8\mu V$. Similarly, $V_S = \pm 2.5V, V_{CM} = 0$ is equivalent to a common-mode voltage change of 2.4V or a V_{OS} change of $7\mu V$ if $CMRR = 110dB (3\mu V/V)$.

A full set of specifications is also provided at $\pm 15V$ supply voltages for comparison with other devices and for completeness.

Single Supply Operation

The LT1078/LT1079 are fully specified for single supply operation, i.e., when the negative supply is 0V. Input common-mode range goes below ground and the output swings within a few millivolts of ground while sinking current. All competing micropower op amps either cannot swing to within 600mV of ground (OP-20, OP-220, OP-420)

APPLICATIONS INFORMATION

or need a pull down resistor connected to the output to swing to ground (OP-90, OP-290, OP-490, HA5141/42/44). This difference is critical because in many applications these competing devices cannot be operated as micro-power op amps and swing to ground simultaneously.

As an example, consider the instrumentation amplifier shown on the front page. When the common-mode signal is low and the output is high, amplifier A has to sink current. When the common-mode signal is high and the output low, amplifier B has to sink current. The competing devices require a 12k pull down resistor at the output of amplifier A and a 15k at the output of B to handle the specified signals. (The LT1078 does not need pull down resistors.) When the common-mode input is high and the output is high these pull down resistors draw $300\mu\text{A}$ ($150\mu\text{A}$ each), which is excessive for micropower applications.

The instrumentation amplifier is by no means the only application requiring current sinking capability. In 7 of the 9 single supply applications shown in this data sheet the op amps have to be able to sink current. In two of the applications the first amplifier has to sink only the 6nA input bias current of the second op amp. The competing devices, however, cannot even sink 6nA without a pull down resistor.

Since the output of the LT1078/LT1079 cannot go exactly to ground, but can only approach ground to within a few millivolts, care should be exercised to ensure that the output is not saturated. For example, a 1 mV input signal will cause the amplifier to set up in its linear region in the gain

100 configuration shown below, but is not enough to make the amplifier function properly in the voltage follower mode.

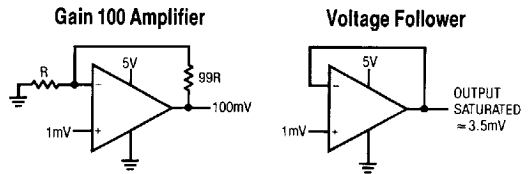

Single supply operation can also create difficulties at the input. The driving signal can fall below 0V—inadvertently or on a transient basis. If the input is more than a few hundred millivolts below ground, two distinct problems can occur on previous single supply designs, such as the LM124, LM158, OP-20, OP-21, OP-220, OP-221, OP-420 (a and b), OP-90/290/490 (b only):

- a) When the input is more than a diode drop below ground, unlimited current will flow from the substrate (V^- terminal) to the input. This can destroy the unit. On the LT1078/LT1079, resistors in series with the input protect the devices even when the input is 5V below ground.
- b) When the input is more than 400mV below ground (at 25°C), the input stage saturates and phase reversal occurs at the output. This can cause lock-up in servo systems. Due to a unique phase reversal protection circuitry, the LT1078/LT1079's output does not reverse, as illustrated below, even when the inputs are at -1.0V .

Voltage Follower with Input Exceeding the Negative Common-Mode Range ($V_S = 5\text{V}, 0\text{V}$)

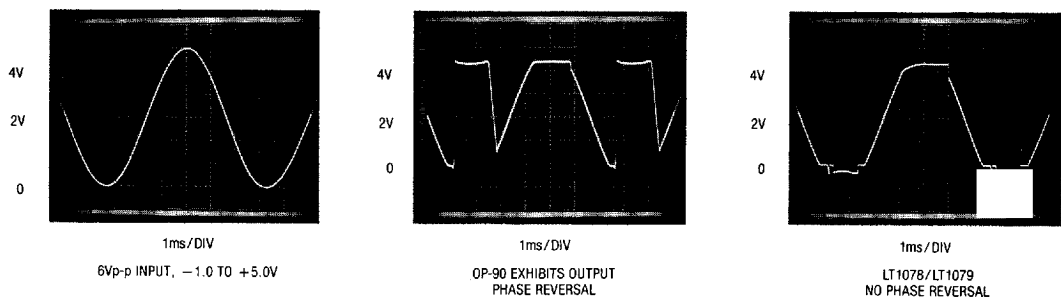

APPLICATIONS INFORMATION

Matching Specifications

In many applications the performance of a system depends on the matching between two op amps, rather than the individual characteristics of the two devices. The two and three op amp instrumentation amplifier configurations shown in this data sheet are examples. Matching characteristics are not 100% tested on the LT1078/79.

Some specifications are guaranteed by definition. For example, $70\mu\text{V}$ maximum offset voltage implies that mismatch cannot be more than $140\mu\text{V}$. 97dB ($= 14\mu\text{V/V}$) CMRR means that worst case CMRR match is 91dB ($= 28\mu\text{V/V}$). However, the following table can be used to estimate the expected matching performance at $V_S = 5\text{V}$, 0V between the two sides of the LT1078, and between amplifiers A and D, and between amplifiers B and C of the LT1079.

PARAMETER		LT1078A/M/A/C LT1079A/M/A/C		LT1078M/C LT1079M/C		UNITS
		50% YIELD	98% YIELD	50% YIELD	98% YIELD	
V_{OS} Match, ΔV_{OS}	LT1078	30	110	50	190	μV
	LT1079	40	150	50	250	
Temperature Coefficient ΔV_{OS}		0.5	1.2	0.6	1.8	$\mu\text{V}/^\circ\text{C}$
Average Non-Inverting I_B		6	8	6	10	nA
Match of Non-Inverting I_B		0.12	0.4	0.15	0.5	nA
CMRR Match		120	100	117	97	dB
PSRR Match		117	105	117	102	dB

Comparator Applications

The single supply operation of the LT1078/1079 and its ability to swing close to ground while sinking current

lends itself to use as a precision comparator with TTL compatible output.

Comparator Rise Response Time to 10mV, 5mV, 2mV Overdrives

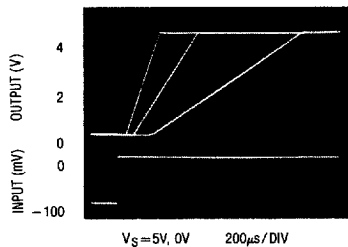

Comparator Fall Response Time to 10mV, 5mV, 2mV Overdrives

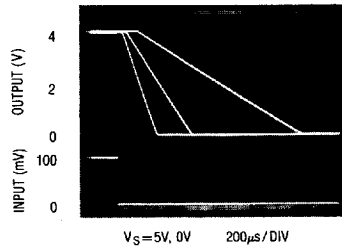

TYPICAL APPLICATIONS

Micropower, 10ppm/°C, ±5V Reference

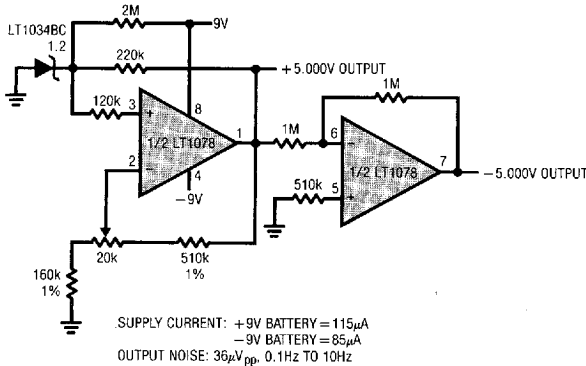

THE LT1078 CONTRIBUTES LESS THAN 3% OF THE TOTAL OUTPUT NOISE AND DRIFT WITH TIME AND TEMPERATURE. THE ACCURACY OF THE -5V OUTPUT DEPENDS ON THE MATCHING OF THE TWO 1M RESISTORS.

Gain of 10 Difference Amplifier

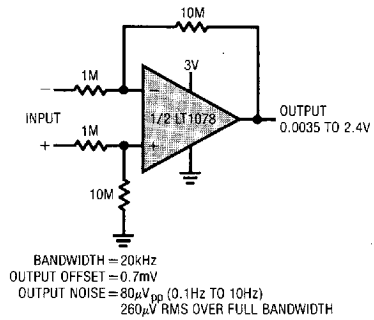

THE USEFULNESS OF DIFFERENCE AMPLIFIERS IS LIMITED BY THE FACT THAT THE INPUT RESISTANCE IS EQUAL TO THE SOURCE RESISTANCE. THE PICO-AMPERE OFFSET CURRENT AND LOW CURRENT NOISE OF THE LT1078 ALLOWS THE USE OF 1MΩ SOURCE RESISTORS WITHOUT DEGRADATION IN PERFORMANCE. IN ADDITION, WITH MEGAOHM RESISTORS MICROPOWER OPERATION CAN BE MAINTAINED.

Picoampere Input Current, Triple Op Amp Instrumentation Amplifier with Bias Current Cancellation

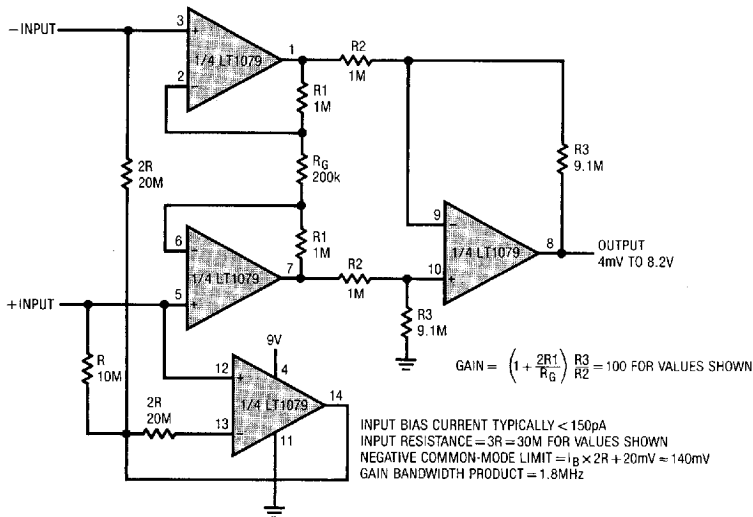

TYPICAL APPLICATIONS

+85V, -100V Common Mode Range Instrumentation Amplifier (Av = 10)

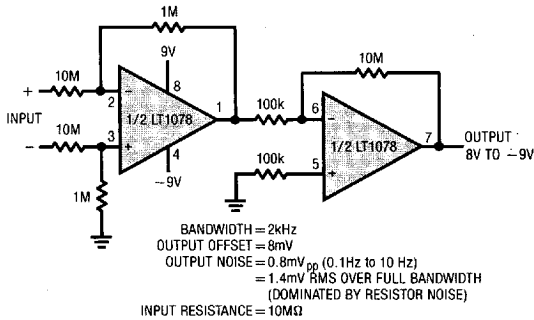

Half-Wave Rectifier

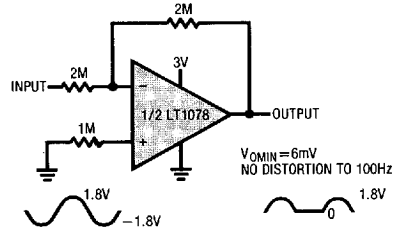

Absolute Value Circuit (Full-Wave Rectifier)

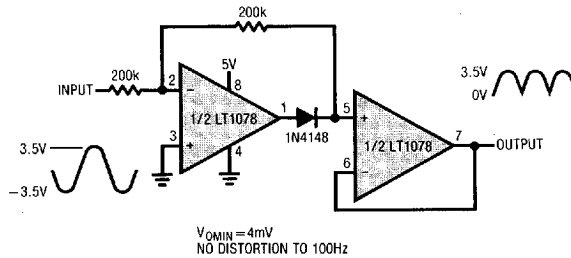

Programmable Gain Amplifier (Single Supply)

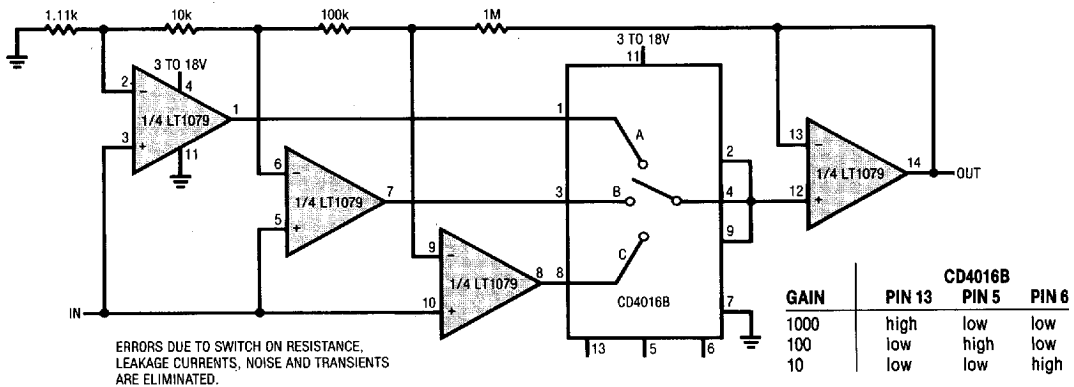

TYPICAL APPLICATIONS

Single Supply, Micropower, Second Order Low Pass Filter with 60Hz Notch

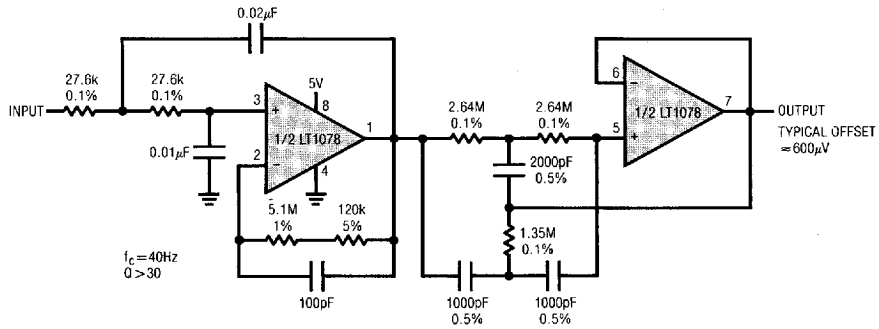

Micropower Multiplier/Divider

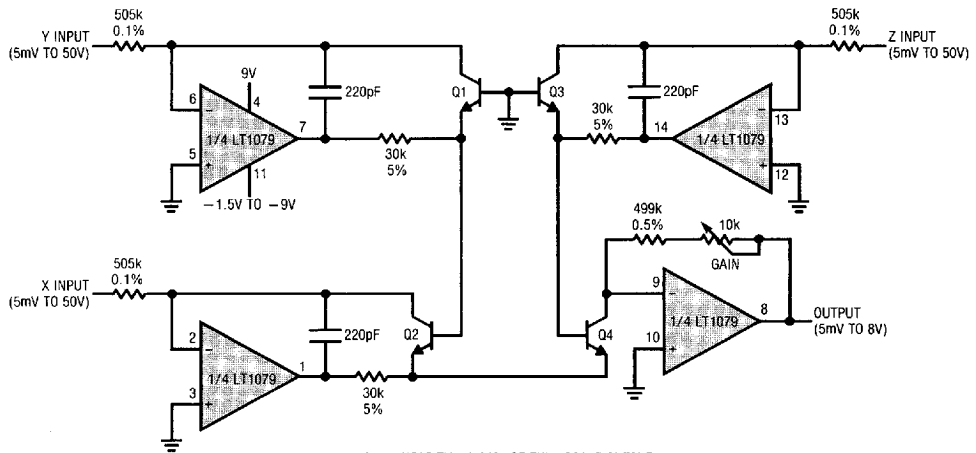

TYPICAL LINEARITY = 0.01% OF FULL SCALE OUTPUT

Q1-Q4 = MAT-04

$$\text{NEGATIVE SUPPLY CURRENT} = 165\mu\text{A} + \frac{X+Y+Z+OUT}{500k}$$

$$\text{OUTPUT} = \frac{(X)(Y)}{(Z)}, \text{ POSITIVE INPUTS ONLY}$$

$$\text{POSITIVE SUPPLY CURRENT} = 165\mu\text{A} + \frac{OUT}{500k}$$

BANDWIDTH (< 3V_{pp} SIGNAL): X AND Y INPUTS = 10kHz
Z INPUT = 4kHz



5518468 0014131 853

TYPICAL APPLICATIONS

Micropower Dead Zone Generator

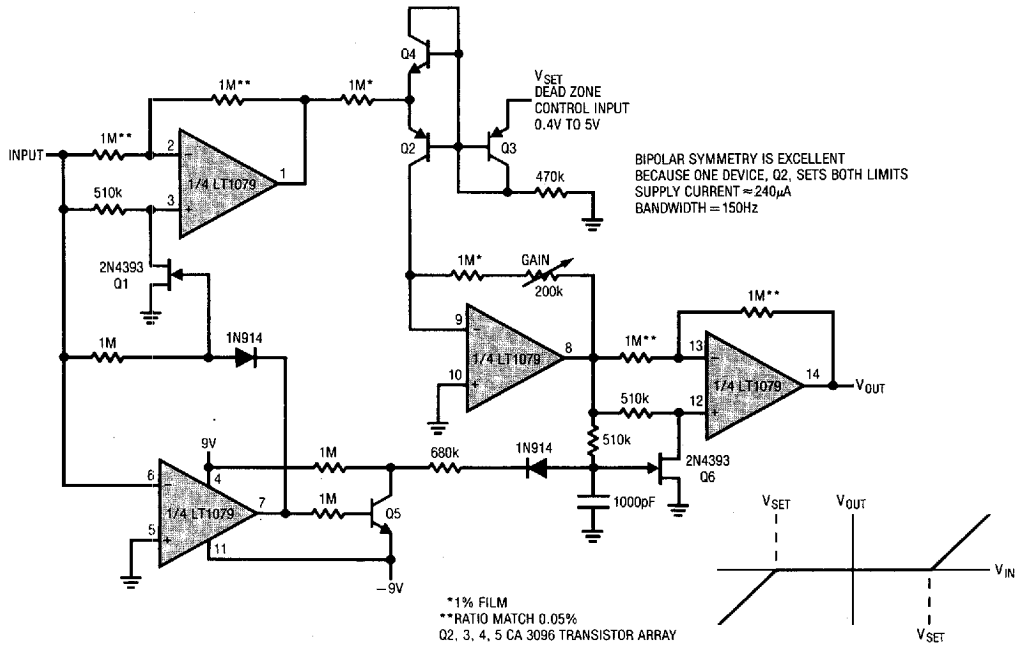

TYPICAL APPLICATIONS

Lead Acid Low Battery Detector with System Shutdown

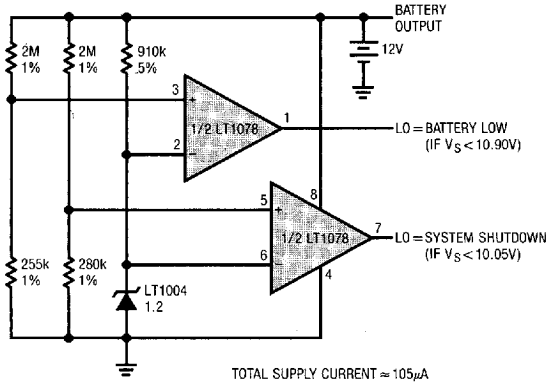

Platinum RTD Signal Conditioner with Curvature Correction

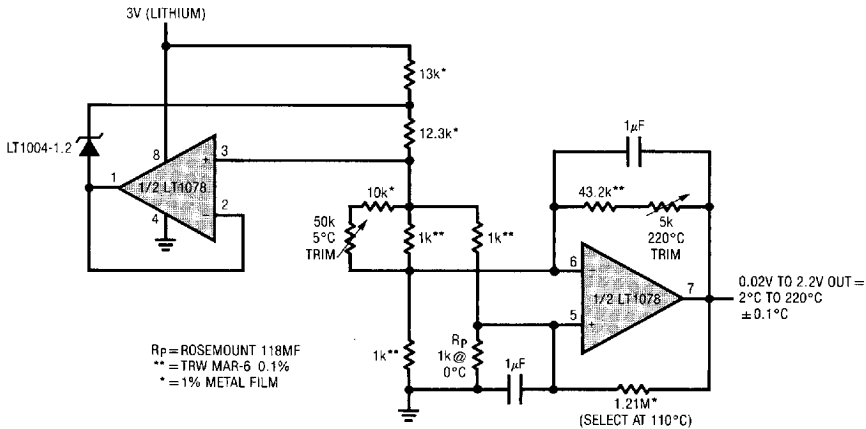

SIMPLIFIED SCHEMATIC

1/2 LT1078
1/4 LT1079

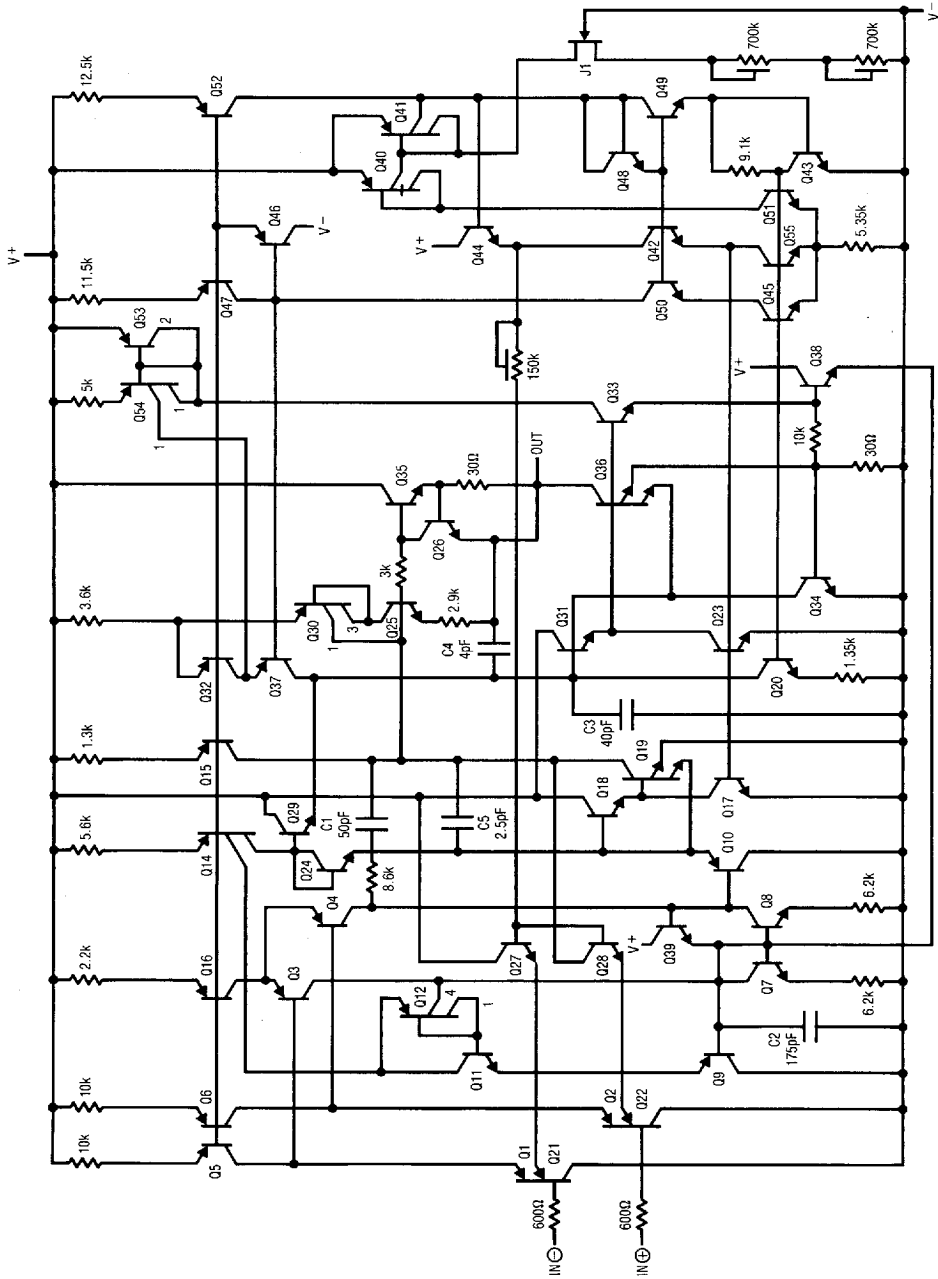

PACKAGE DESCRIPTION

Dimension in inches (millimeters) unless otherwise noted.

**H Package
8-Lead TO-5 Metal Can**

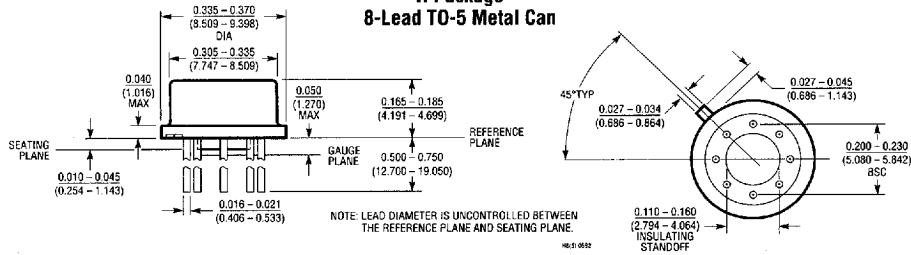

**J8 Package
8-Lead Ceramic DIP**

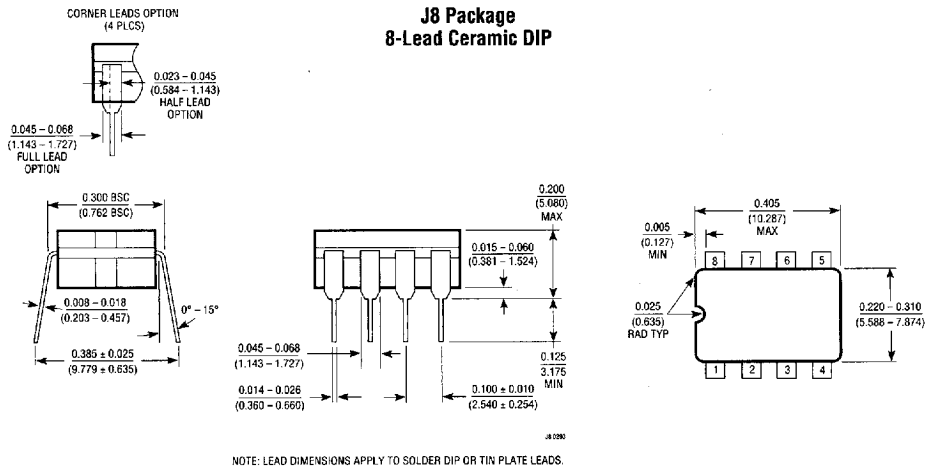

**J Package
14-Lead Ceramic DIP**

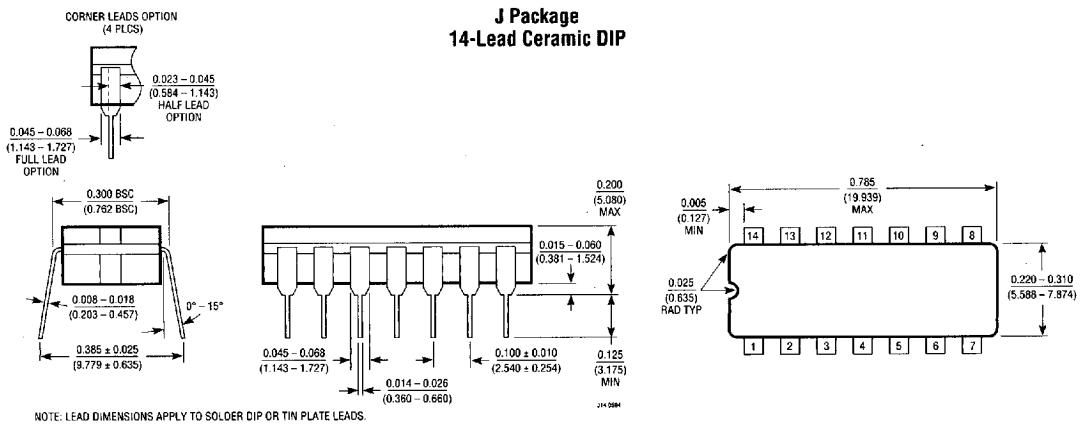

Information furnished by Linear Technology Corporation is believed to be accurate and reliable. However, no responsibility is assumed for its use. Linear Technology Corporation makes no representation that the interconnection of its circuits as described herein will not infringe on existing patent rights.

5518468 0014135 4T9

LT1078/LT1079

PACKAGE DESCRIPTION Dimension in inches (millimeters) unless otherwise noted.

N8 Package
8-Lead Plastic DIP

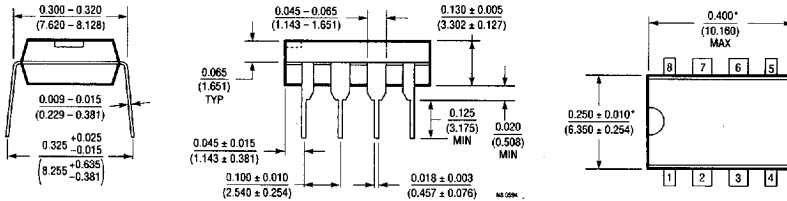

*THESE DIMENSIONS DO NOT INCLUDE MOLD FLASH OR PROTRUSIONS.
MOLD FLASH OR PROTRUSIONS SHALL NOT EXCEED 0.010 INCH (0.254mm).

N Package
14-Lead Plastic DIP

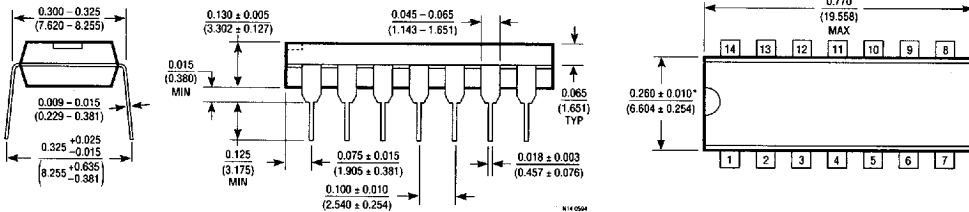

*THESE DIMENSIONS DO NOT INCLUDE MOLD FLASH OR PROTRUSIONS.
MOLD FLASH OR PROTRUSIONS SHALL NOT EXCEED 0.010 INCH (0.254mm).

S8 Package
8-Lead Small Outline

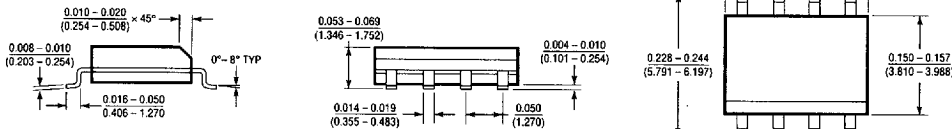

*THESE DIMENSIONS DO NOT INCLUDE MOLD FLASH OR PROTRUSIONS.
MOLD FLASH OR PROTRUSIONS SHALL NOT EXCEED 0.006 INCH (0.15mm).

SOL Package
16-Lead Small Outline (Wide)

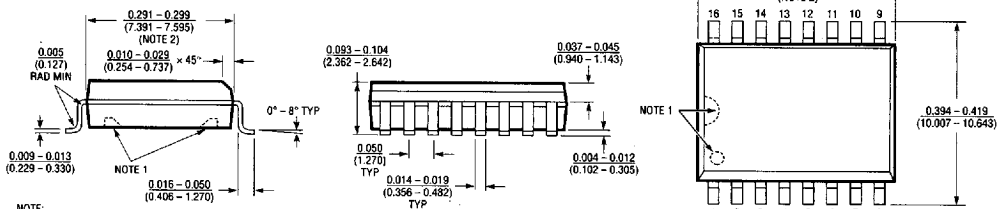

NOTE:
1. PIN 1 IDENT. NOTCH ON TOP AND CAVITIES ON THE BOTTOM OF PACKAGES ARE THE MANUFACTURING OPTIONS. THE PART MAY BE SUPPLIED WITH OR WITHOUT ANY OF THE OPTIONS.
2. THESE DIMENSIONS DO NOT INCLUDE MOLD FLASH OR PROTRUSIONS.
MOLD FLASH OR PROTRUSIONS SHALL NOT EXCEED 0.006 INCH (0.15mm).

68581

20 Linear Technology Corporation
1630 McCarthy Blvd., Milpitas, CA 95035-7487
(408) 432-1900 • FAX: (408) 434-0507 • TELEX: 499-3977

BA/GP 0694 5K REV C • PRINTED IN USA
LINEAR TECHNOLOGY
© LINEAR TECHNOLOGY CORPORATION 1994