



KSS

- Home
- About KSS
- Contact Us
- What's New
- New Product
- Our Products
- Search

0710 KSS Snap Bushing



- Material: UL approved Nylon 66, 94V-2
- Color: Black
- KSS SNAP BUSHING smooth and insulate your raw-edged holes in metal chassis.
- Locking into hole firmly with fingertip pressure.
- Protect electrical cables, ropes, utility lines through metal holes.
- Available in application for chassis thickness Under 3.2mm

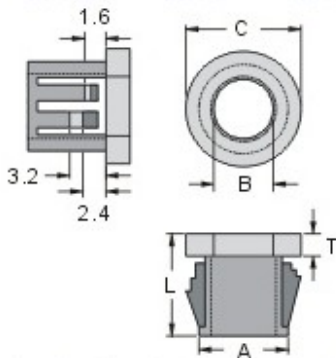

Standard Design

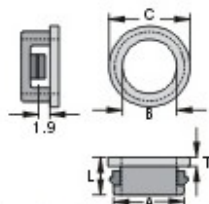

SB-7S, 8S, 12S, 22S

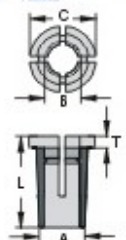

















SBP-8

※ SB-8A: available for chassis thickness under 2.2 mm

※ SB-8: available for chassis thickness under 1.6 mm

Unit: mm

	Item No.	Mounting Hole A	B	C	L	T	Packing
	□ SB-7S	7.1	5.8	8.8	6.1	1.3	100 pcs / Bag
	□ SB-8S	7.9	6.8	9.8	6.0	1.5	
	□ SB-12S	11.9	9.2	13.7	6.3	1.5	
	□ SB-22S	22.2	19.6	24.0	6.5	1.5	
※ 	□ SB-8A	7.9	5.1	10.5	8.0	1.6	
※ 	□ SB-8	7.9	5.8	10.5	8.0	1.6	
	□ SBP-8	7.4	5.9	10.8	15.0	2.0	
	□ SB-10	9.5	6.4	12.0	10.3	1.6	
	□ SB-10M	9.5	7.8	13.0	10.5	1.6	
	□ SB-13	12.7	8.0	15.0	10.3	1.6	
	□ SB-14	14.3	11.4	17.0	10.3	1.5	
	□ SB-16	15.9	12.7	18.6	10.3	1.6	
	□ SB-19	19.1	14.3	21.7	10.3	1.6	
	□ SB-19M	19.1	15.8	21.7	10.3	1.6	
	□ SB-20	20.0	15.9	22.4	10.0	1.4	
	□ SB-22	22.2	17.5	24.2	11.5	1.6	
	□ SB-22M	22.2	18.9	24.2	11.5	1.6	
	□ SB-25	25.4	19.5	28.5	11.7	1.8	
	□ SB-26	25.8	19.1	28.5	11.5	1.6	
	□ SB-30	30.1	24.1	33.3	11.5	1.6	
	□ SB-32	32.0	23.8	34.6	11.4	1.5	
	□ SB-38	38.1	29.0	42.1	11.4	1.5	
	□ SB-45	44.5	35.4	47.8	11.6	1.5	
	□ SB-50	50.8	41.6	54.6	11.8	1.6	