

# HM4864-2, HM4864-3 HM4864P-2, HM4864P-3

## 65536-word × 1-bit Dynamic Random Access Memory

The HM4864 is a 65,536-words by 1-bit, MOS random access memory circuit fabricated with HITACHI's double-poly N-channel silicon gate process for high performance and high functional density. The HM4864 uses a single transistor dynamic storage cell and dynamic control circuitry to achieve high speed and low power dissipation.

Multiplexed address inputs permit the HM4864 to be packaged in a standard 16 pin DIP on 0.3 inch centers.

This package size provides high system bit densities and is compatible with widely available automated testing and insertion equipment. System oriented features include single power supply of +5V with ±10% tolerance, direct interfacing capability with high performance logic families such as Schottky TTL, maximum input noise immunity to minimize "false triggering" of the inputs, on-chip address and data registers which eliminate the need for interface registers, and two chip select methods to allow the user to determine the appropriate speed/power characteristics of this memory system. The HM4864 also incorporates several flexible timing/operating modes.

In addition to the usual read, write, and read-modify-write cycles, the HM4864 is capable of delayed write cycles, page-mode operation and RAS-only refresh.

Proper control of the clock inputs ( $\overline{RAS}$ ,  $\overline{CAS}$ , and  $\overline{WE}$ ) allows common I/O capability, two dimensional chip selection, and extended page boundaries (when operating in page mode).

### ■ FEATURES

- Recognized industry standard 16-pin configuration
- 150ns access time, 270ns cycle time (HM4864-2, HM4864P-2)
- 200ns access time, 335ns cycle time (HM4864-3, HM4864P-3)
- Single power supply of +5V±10% with a built-in  $V_{BB}$  generator
- Low Power; 330 mW active, 20 mW standby (max)
- The inputs TTL compatible, low capacitance, and protected against static charge
- Output data controlled by  $\overline{CAS}$  and unlatched at end of cycle to allow two dimensional chip selection and extended page boundary
- Common I/O capability using "early write" operation
- Read-Modify-Write, RAS-only refresh, and Page-mode capability
- 128 refresh cycle

HM4864-2, HM4864-3

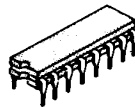

(DG-16A)

HM4864P-2, HM4864P-3



(DP-16)

### ■ PIN ARRANGEMENT

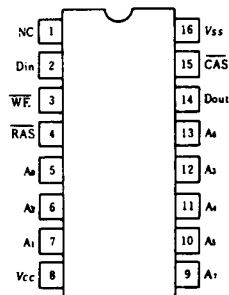

(Top View)

$A_0-A_4$	Address Inputs
$\overline{CAS}$	Column Address Strobe
Din	Data In
Dout	Data Out
$\overline{RAS}$	Row Address Strobe
$\overline{WE}$	Read/Write Input
$V_{CC}$	Power (+5V)
$V_{SS}$	Ground
$A_0-A_4$	Refresh Address Input



**FUNCTIONAL BLOCK DIAGRAM**

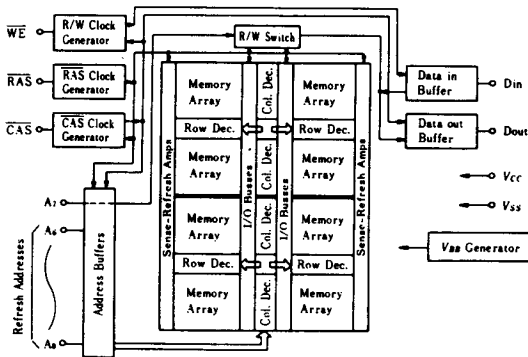

**ABSOLUTE MAXIMUM RATINGS**

Voltage on any pin relative to  $V_{SS}$  ..... -1.0 to +7V  
 Operating Temperature,  $T_a$  (Ambient) ..... 0 to +70°C  
 Storage Temperature (Ambient) ..... -65 to +150°C (Cerdip)  
 ..... -55 to +125°C (Plastic)  
 Short-circuit Output Current . 50 mA  
 Power Dissipation ..... 1 W

**RECOMMENDED DC OPERATING CONDITIONS ( $T_a=0$  to +70°C)**

Parameter	Symbol	min	typ	max	Unit	Notes
Supply Voltage	$V_{CC}$	4.5	5.0	5.5	V	1
	$V_{SS}$	0	0	0	V	
Input High Voltage	$V_{IH}$	2.4	—	6.5	V	1
Input Low Voltage	$V_{IL}$	-1.0	—	0.8	V	1

**DC ELECTRICAL CHARACTERISTICS ( $T_a=0$  to +70°C,  $V_{CC}=5V \pm 10\%$ ,  $V_{SS}=0V$ )**

Parameter	Symbol	min	max	Unit	Notes
<b>OPERATING CURRENT</b>					
Average Power Supply Operating Current ( $\overline{RAS}, \overline{CAS}$ Cycling; $t_{RC} = \text{min.}$ )	$I_{CC1}$	—	60	mA	2, 4
<b>STANDBY CURRENT</b>					
Power Supply Standby Current ( $\overline{RAS} = V_{IH}, \text{Dout} = \text{High Impedance}$ )	$I_{CC2}$	—	3.5	mA	2
<b>REFRESH CURRENT</b>					
Average Power Supply Current, Refresh Mode ( $\overline{RAS}$ Cycling, $\overline{CAS} = V_{IH}; t_{RC} = \text{min.}$ )	$I_{CC3}$	—	45	mA	2, 4
<b>PAGE MODE CURRENT</b>					
Average Power Supply Current, Page-mode Operation ( $\overline{RAS} = V_{IL}, \overline{CAS}$ Cycling; $t_{PC} = \text{min.}$ )	$I_{CC4}$	—	45	mA	2, 4
<b>INPUT LEAKAGE</b>					
Input Leakage Current, any Input ( $V_i = 0$ to +6.5V, all other pins not under test = 0V)	$I_{LI}$	-10	10	$\mu A$	
<b>OUTPUT LEAKAGE</b>					
Output Leakage Current (Dout is disabled, $V_{out} = 0$ to +5.5V)	$I_{LO}$	-10	10	$\mu A$	3
<b>OUTPUT LEVELS</b>					
Output High (Logic 1) Voltage ( $I_{out} = -5\text{mA}$ )	$V_{OH}$	2.4	$V_{CC}$	V	
Output Low (Logic 0) Voltage ( $I_{out} = 4.2\text{mA}$ )	$V_{OL}$	0	0.4	V	

**NOTES**

1. All voltages referenced to  $V_{SS}$ .
2.  $I_{CC}$  depends on output loading condition when the device is selected.  $I_{CC}$  max. is specified at the output open condition.
3.  $I_{LO}$  consists of leakage current only.
4. Current depends on cycle rate: maximum current is measured at the fastest cycle rate.

**AC ELECTRICAL CHARACTERISTICS**

Parameter	Symbol	typ	max	Unit	Notes
Input Capacitance ( $A_0-A_7, \text{Din}$ )	$C_{i1}$	—	7	pF	1
Input Capacitance ( $\overline{RAS}, \overline{CAS}, \overline{WE}$ )	$C_{i2}$	—	10	pF	1
Output Capacitance (Dout)	$C_{out}$	—	7	pF	1, 2

**NOTES**

1. Capacitance measured with Boonton Meter or effective capacitance measuring method.
2.  $\overline{CAS} = V_{IH}$  to disable  $\text{DOUT}$ .

ELECTRICAL CHARACTERISTICS AND RECOMMENDED AC OPERATING CONDITIONS <sup>1), 2)</sup>

(Ta=0 to +70°C, Vcc=5V±10%, Vss=0V)

Parameter	Symbol	HM4864-2/P-2		HM4864-3/P-3		Unit	Notes
		min	max	min	max		
Random Read or Write Cycle Time	$t_{RC}$	270	—	335	—	ns	
Read-Write Cycle Time	$t_{RWC}$	270	—	335	—	ns	
Page Mode Cycle Time	$t_{PC}$	170	—	225	—	ns	
Access Time from RAS	$t_{RAC}$	—	150	—	200	ns	4, 6
Access Time from CAS	$t_{CAC}$	—	100	—	135	ns	5, 6
Output Buffer Turn-off Delay	$t_{OFF}$	0	40	0	50	ns	7
Transition Time (Rise and Fall)	$t_T$	3	35	3	50	ns	3
RAS Precharge Time	$t_{RP}$	100	—	120	—	ns	
RAS Pulse Width	$t_{RAS}$	150	10000	200	10000	ns	
RAS Hold Time	$t_{RSH}$	100	—	135	—	ns	
CAS Pulse Width	$t_{CAS}$	100	—	135	—	ns	
CAS Hold Time	$t_{CSH}$	150	—	200	—	ns	
RAS to CAS Delay Time	$t_{ACD}$	20	50	25	65	ns	8
CAS to RAS Precharge Time	$t_{CRP}$	-20	—	-20	—	ns	
Row Address Set-up Time	$t_{ASR}$	0	—	0	—	ns	
Row Address Hold Time	$t_{RAH}$	20	—	25	—	ns	
Column Address Set-up Time	$t_{ASC}$	-10	—	-10	—	ns	
Column Address Hold Time	$t_{CAH}$	45	—	55	—	ns	
Column Address Hold Time referenced to RAS	$t_{AR}$	95	—	120	—	ns	
Read Command Set-up Time	$t_{ACS}$	0	—	0	—	ns	
Read Command Hold Time	$t_{RCH}$	0	—	0	—	ns	
Write Command Hold Time	$t_{WCH}$	45	—	55	—	ns	
Write Command Hold Time referenced to RAS	$t_{WCR}$	95	—	120	—	ns	
Write Command Pulse Width	$t_{WP}$	45	—	55	—	ns	
Write Command to RAS Lead Time	$t_{RWL}$	45	—	55	—	ns	
Write Command to CAS Lead Time	$t_{CWL}$	45	—	55	—	ns	
Data-in Set-up Time	$t_{DS}$	0	—	0	—	ns	9
Data-in Hold Time	$t_{DH}$	45	—	55	—	ns	9
Data-in Hold Time referenced to RAS	$t_{DHR}$	95	—	120	—	ns	
CAS Precharge Time (for Page-mode Cycle Only)	$t_{CP}$	60	—	80	—	ns	
Refresh Period	$t_{REF}$	—	2	—	2	ms	
Write Command Set-up Time	$t_{WCS}$	-20	—	-20	—	ns	10
CAS to WE Delay	$t_{CWD}$	60	—	80	—	ns	10
RAS to WE Delay	$t_{RWD}$	110	—	145	—	ns	10
RAS Precharge to CAS Hold Time	$t_{RPC}$	0	—	0	—	ns	

## NOTES

- AC measurements assume  $t_T = 5ns$ .
- 8 cycles are required after power-on or prolonged periods (greater than 2ms) of RAS inactivity before proper device operation is achieved. Any 8 cycles which perform refresh are adequate for this purpose.
- $V_{IH}$  (min) and  $V_{IL}$  (max) are reference levels for measuring timing of input signals. Also, transition times are measured between  $V_{IH}$  and  $V_{IL}$ .
- Assumes that  $t_{RCD} \leq t_{RCD}(\max)$ . If  $t_{RCD}$  is greater than the maximum recommended value shown in this table  $t_{RAC}$  exceeds the value shown.
- Assumes that  $t_{RCD} \geq t_{RCD}(\max)$ .
- Measured with a load circuit equivalent to 2TTL loads and 100 pF.
- $t_{OFF}(\max)$  defines the time at which the output achieves the open circuit condition and is not referenced to output voltage levels.
- Operation with the  $t_{RCD}(\max)$  limit insures that

$t_{RAC}(\max)$  can be met.  $t_{RCD}(\max)$  is specified as a reference point only; if  $t_{RCD}$  is greater than the specified  $t_{RCD}(\max)$  limit, then access time is controlled exclusively by  $t_{CAC}$ .

- These parameters are reference to  $\overline{CAS}$  leading edge in early write cycles and to  $\overline{WE}$  leading edge in delayed write or read-modify-write cycles.
- $t_{WCS}$ ,  $t_{CWD}$  and  $t_{RWD}$  are not restrictive operating parameters. They are included in the data sheet as electrical characteristics only: if  $t_{WCS} \geq t_{WCS}(\min)$ , the cycle is an early write cycle and the data out pin will remain open circuit (high impedance) throughout the entire cycle; if  $t_{CWD} \geq t_{CWD}(\min)$  and  $t_{RWD} \geq t_{RWD}(\min)$  the cycle is a read/write and the data output will contain data read from the selected cell; if neither of the above sets of conditions is satisfied the condition of the data out (at access time) is indeterminate.



■ TIMING WAVEFORMS

● READ CYCLE

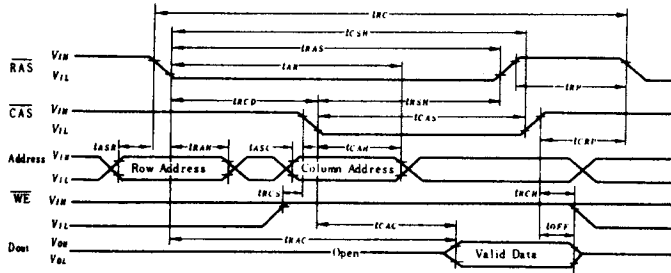

● WRITE CYCLE

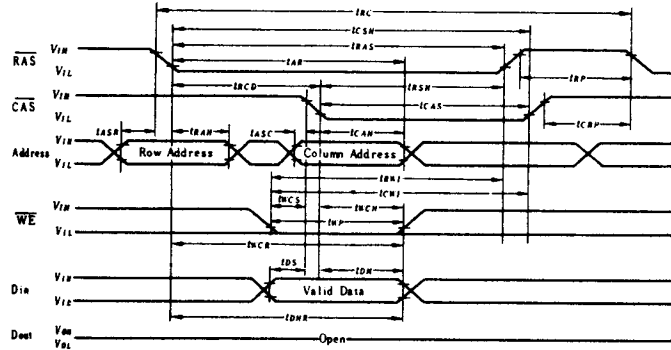

● READ-WRITE/READ-MODIFY-WRITE CYCLE

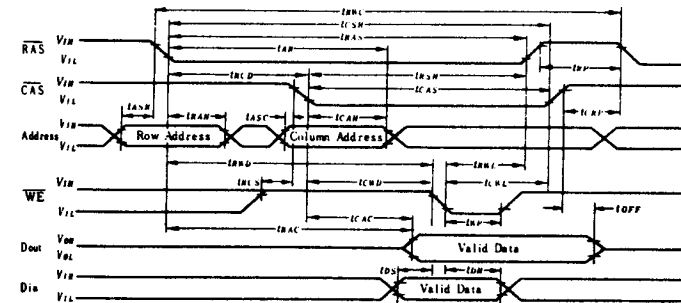

● "RAS-ONLY" REFRESH CYCLE

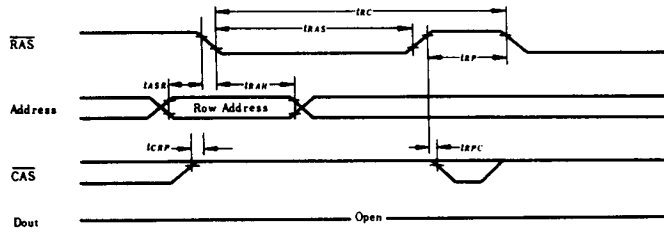

● PAGE MODE READ CYCLE

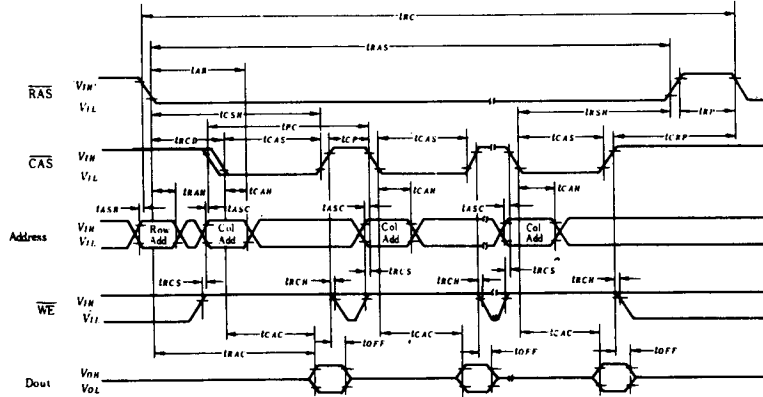

● PAGE MODE WRITE CYCLE

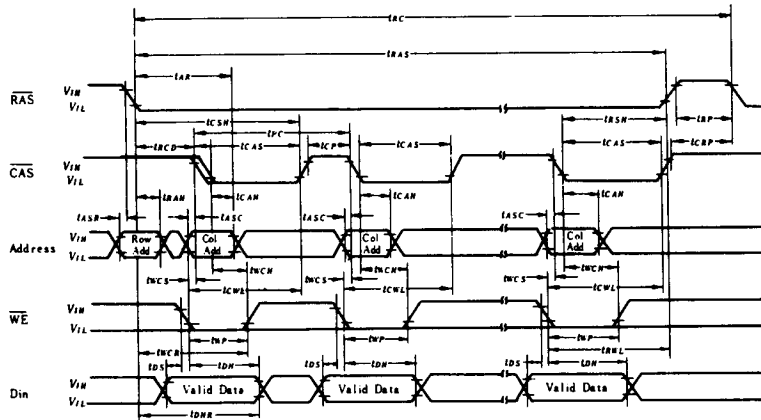

■ TYPICAL CHARACTERISTICS

**ACCESS TIME vs. SUPPLY VOLTAGE**

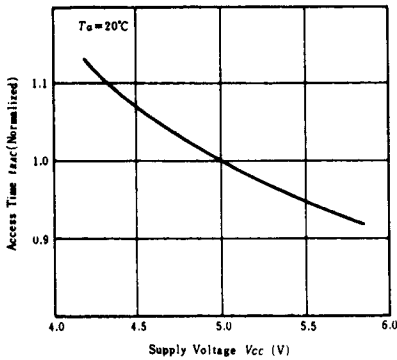

**ACCESS TIME vs. AMBIENT TEMPERATURE**

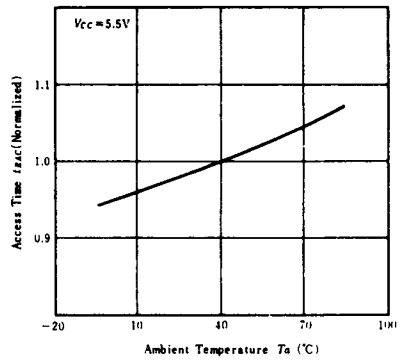

**SUPPLY CURRENT vs. SUPPLY VOLTAGE**

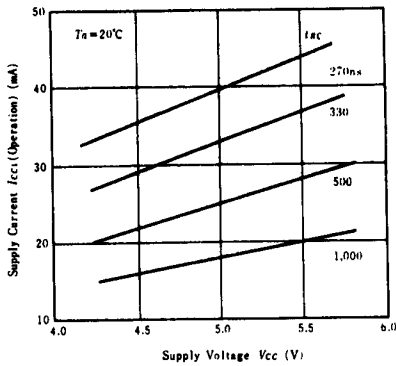

**SUPPLY CURRENT vs. AMBIENT TEMPERATURE**

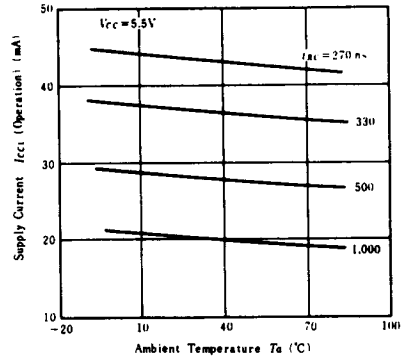

**SUPPLY CURRENT vs. CYCLE RATE**

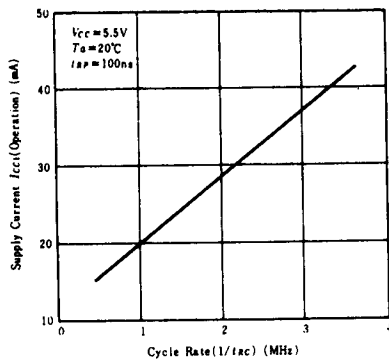

**SUPPLY CURRENT vs. SUPPLY VOLTAGE**

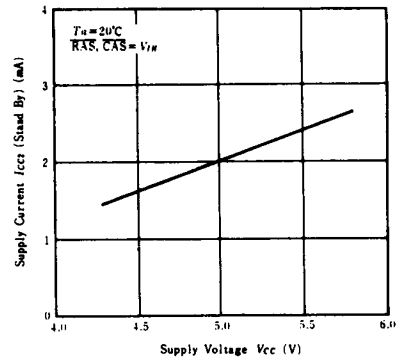

**SUPPLY CURRENT vs. AMBIENT TEMPERATURE**

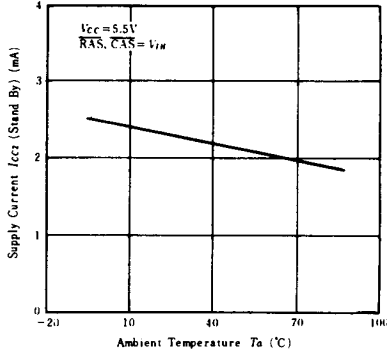

**SUPPLY CURRENT vs. SUPPLY VOLTAGE**

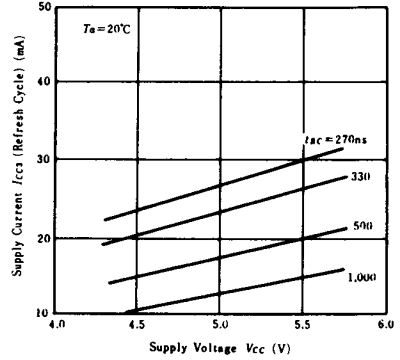

**SUPPLY CURRENT vs. AMBIENT TEMPERATURE**

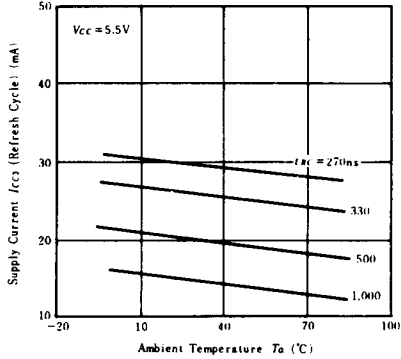

**SUPPLY CURRENT vs. CYCLE RATE**

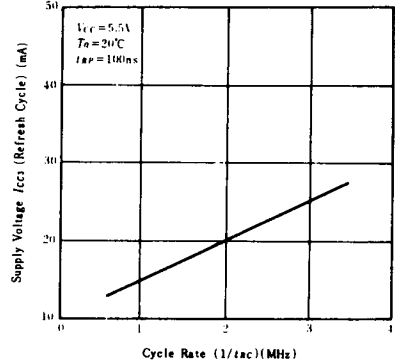

**SUPPLY CURRENT vs. SUPPLY VOLTAGE**

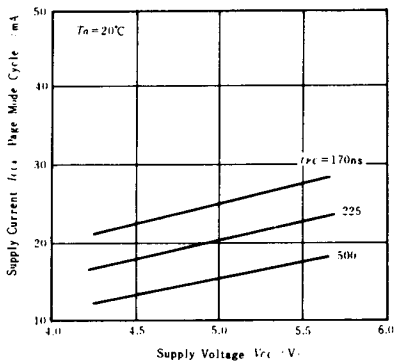

**SUPPLY CURRENT vs. AMBIENT TEMPERATURE**

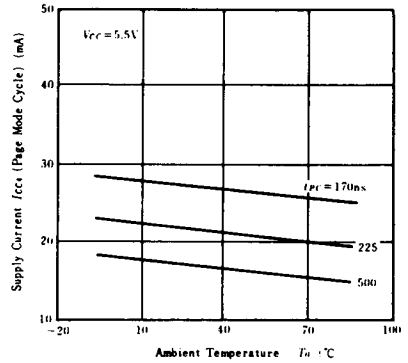

**SUPPLY CURRENT  
vs. CYCLE RATE**

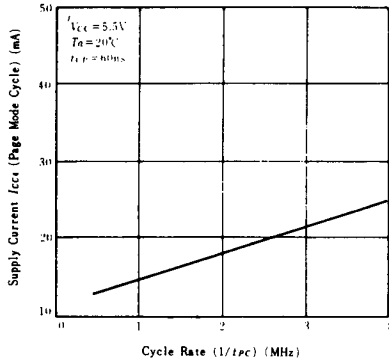

**INPUT LEVEL  
vs. SUPPLY VOLTAGE**

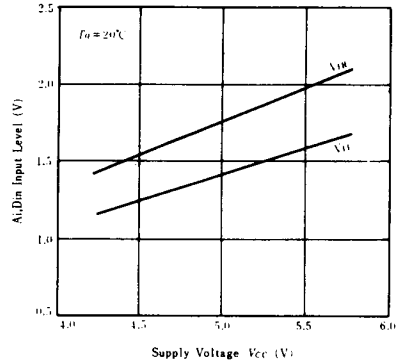

**INPUT LEVEL  
vs. AMBIENT TEMPERATURE**

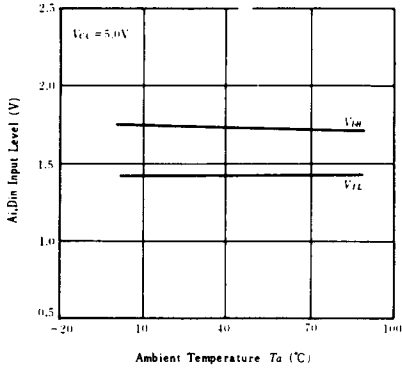

**CLOCK INPUT LEVEL  
vs. SUPPLY VOLTAGE**

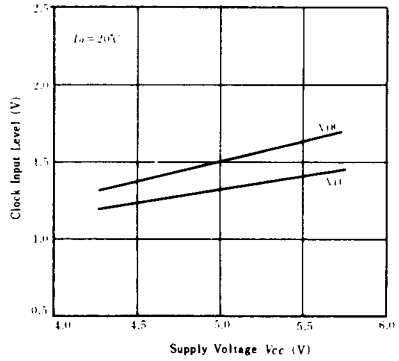

**CLOCK INPUT LEVEL  
vs. AMBIENT TEMPERATURE**

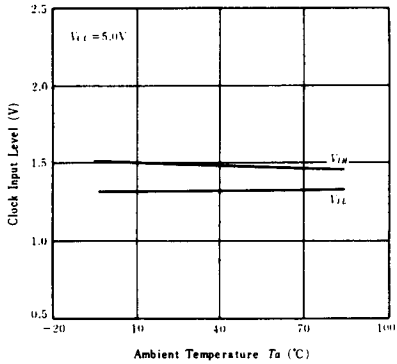



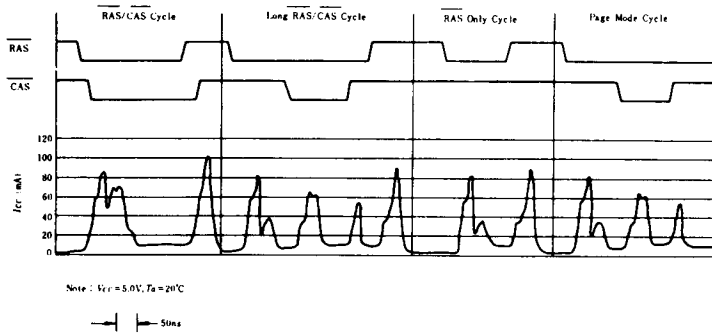

■ APPLICATION INFORMATION

● POWER ON

An initial pause of 500  $\mu s$  is required after power-up and a minimum of eight (8) initialization cycle,(any combination of cycles containing a RAS clock such as RAS-only refresh) must follow an initial pause.

The  $V_{CC}$  current ( $I_{CC}$ ) requirement of the HM4864 during power on is, however, dependent upon the input levels (RAS,  $\overline{CAS}$ ) and the rise time of  $V_{CC}$ , as shown in Fig. 1.

● READ CYCLE

A read cycle begins with addresses stable and a negative going transition of RAS. The time delay between the stable address and the start of RAS-on is controlled by parameter  $t_{ASR}$ .

Following the time when RAS reaches its low level, the row address must be held stable long enough to be captured. This controlling parameter is  $t_{RAH}$ . Following this interval, the address can be changed from row address to column address. When the column address is stable, CAS can be turned on. The leading edge of  $\overline{CAS}$  is controlled by parameter  $t_{RCD}$ . The basic limit on the  $\overline{CAS}$  leading edge is that  $\overline{CAS}$  can not start until the column address is stable, and this is controlled by parameter  $t_{ASC}$ . The column address must be held stable long enough to be captured. The controlling parameter is  $t_{CAH}$ . Note that  $t_{RCD}$  (max) is not an operating limit of the HM4864 though its specification is listed on the data sheets. If  $\overline{CAS}$  becomes on later than  $t_{RCD}$  (max), the access time from RAS will be increased by the time which  $t_{RCD}$  exceeds  $t_{RCD}$  (max).

Following the time when  $\overline{CAS}$  reaches its low level, the data-out pin remains in a high impedance state until a valid data appears. This parameter is  $t_{CAC}$ -access time from  $\overline{CAS}$ .

The access time from RAS— $t_{RAC}$ —is the time from RAS-on to valid Dout.

The minimum value of  $t_{RAC}$  is derived as the sum of  $t_{RCD}$  (max) and  $t_{CAC}$ .

The selected output data is held valid internally until  $\overline{CAS}$  becomes high, and then Dout pin becomes high impedance.

This parameter is  $t_{OFF}$ .

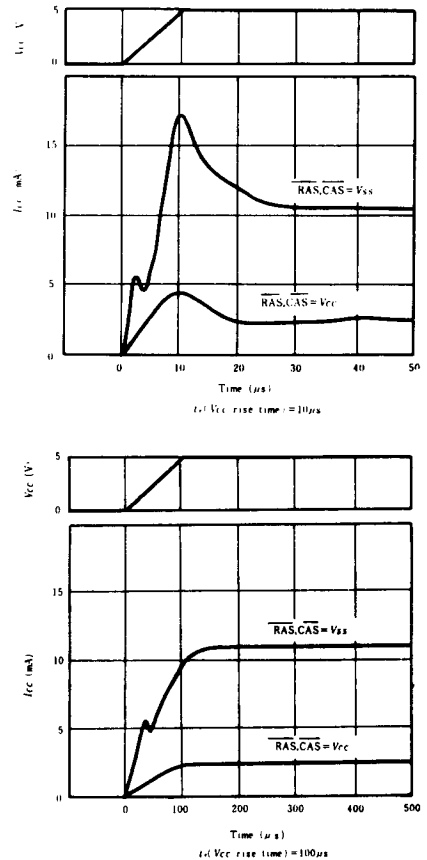

Fig.1  $I_{CC}$  vs.  $V_{CC}$  during power up.

#### ● WRITE CYCLE

A write cycle is performed by bringing  $\overline{WE}$  low before or during  $\overline{CAS}$ -on.

Two different write cycles can be defined as:

**Write cycle**—Write data are available at the beginning of the  $\overline{CAS}$ -on so that the write operation starts at the beginning. In this mode,  $Dout$  and  $\overline{WE}$  signal times are not in any critical path for determining cycle time.

Following the time when  $\overline{WE}$  reaches its low level,  $\overline{WE}$  must be held stable long enough to be captured. This  $\overline{WE}$ -on pulse duration is called  $t_{WP}$ . The time required to capture write data in a latch is called  $t_{DH}$ . This cycle is called an "early write".

**Read Write cycle**—This cycle starts as a read cycle, but as soon as the device specification is met, a write cycle is initiated.

$\overline{WE}$  and  $Din$  are delayed until after  $Dout$ . This cycle is called a "delayed write". A "Read-modify-write" cycle is a variation of this operation. In this mode,  $Din$  and  $\overline{WE}$  become critical path signals for determining cycle time.

#### ● CLOCK-OFF TIMING

$\overline{RAS}$  and  $\overline{CAS}$  must stay on for  $Dout$  stabilized to valid data. In the case of  $\overline{CAS}$ , this is controlled by parameter  $t_{CAS}$  (min).

In the case of  $\overline{RAS}$ , this is controlled by parameter  $t_{CAS}$  (min). Following the end of  $\overline{RAS}$ ,  $\overline{CAS}$  must stay off long enough to precharge internal circuits. The only parameter of concern is  $t_{RP}$ . Normally  $\overline{CAS}$  is not required to be off for minimum time of  $t_{CRP}$ . However, in a page mode memory operation, there is a  $t_{CP}$  (min) specification to control the  $\overline{CAS}$ -off time.

#### ● DATA OUTPUT

$Dout$  is three-state TTL compatible with a fan-out of two standard TTL loads.

When  $\overline{CAS}$  is high,  $Dout$  is in a high impedance state. When  $\overline{CAS}$  is low, valid data appears after  $t_{CAC}$  at a read cycle, and  $Dout$  is not valid as an early-write cycle.

#### ● REFRESH

Refresh of the HM4864 is accomplished by performing a memory cycle at each of the 128 row addresses within each two millisecond time interval. A0 to A6 are refresh address pin compatible with standard 16K RAM (HM4716A, HM4816A). During refresh, either  $V_{IL}$  or  $V_{IH}$  is permitted for A7. Any cycle in which  $\overline{RAS}$  signal occurs refreshes the entire selected row.  $\overline{RAS}$ -only refresh results in substantial reduction in operating power. This reduction in power is reflected in the  $I_{CC3}$  specification.

#### ● PAGE MODE

Page mode operation allows faster successive memory operations at multiple column locations of the same row address with increased speed.

This is done by strobing the row address into the chip and maintaining  $\overline{RAS}$  at a logic low throughout all successive  $\overline{CAS}$  memory cycles in which the row address is latched. As the time normally required for strobing a new row address is eliminated, access and cycle times can be decreased and the operating power is reduced. These are specifications.